

# Assessment of Flexural Strength and Fractography Analysis of Honeycomb Sandwiched Material Reinforced with Natural Fibres for Construction Industry Applications

Nahiyan Al-Azad<sup>1</sup>, Mohd. Kamal Mohd. Shah<sup>2</sup>

<sup>1</sup>Advanced Composite and Material Research Group (Environmental and Health Technology), Faculty of Engineering, Universiti Malaysia Sabah, <sup>2</sup>Advanced Composite and Material Research Group (Environmental and Health Technology), Faculty of Engineering, Universiti Malaysia Sabah

Email: mkamalms@ums.edu.my

Corresponding Author Email: turjo93@gmail.com

To Link this Article: <http://dx.doi.org/10.6007/IJARBSS/v14-i3/21044>

DOI:10.6007/IJARBSS/v14-i3/21044

**Published Date:** 06 March 2024

## Abstract

One of humanity's oddest features is that it uses a tremendous number of resources, even non-renewable ones, while leaving indications of pollution in its wake. The most important environmental threat associated with its production is not the depletion of non-renewable raw resources, but rather the environmental effects of its extraction, which include massive deforestation and topsoil degradation. As a result, new and inventive construction materials or substitute materials are required to address this issue. The usage of natural fibre honeycomb sandwich structure (NFHSS) composite material as an alternative building material has various advantages over standard building materials, including decreased weight, increased strength, and durability, improved thermal and acoustic insulation, and more design flexibility. This research analysis the flexural strength of the NFHSS to be used as potential flooring panel or slab as an alternative building material. Following the flexural strength analysis, a fractography study has been conducted in order to identify the failure mode of the NFHSS. ASTM D7249 was used to execute the flexural strength of the material on a Universal Tester Machine. The maximum deflection that the material can withstand before failing is 0.5mm at a force of 4.52kN. The stiffness of this material was determined to be 2.26 kN/mm, and it was classified as ductile. This study's findings support the idea that weak interfacial bonding causes fibre and matrix breakdown are the main causes of the material failure.

**Introduction**

Many building structural components, such as concrete, timbers, and slabs, are prone to flexing or twisting. It is critical that these construction elements have flexural strength and can withstand bending or tensile stresses. The precise degree of flexural strength needed, however, changes depending on what role the material plays in the strength of a structure. With concrete and timber wood being the most conventional material to be used as building material due to its well-known properties in terms of strength, recent research shows that there is a call for new materials to be introduced in the construction industry to replace these conventional material to be incorporated as structural material.

Pacheco-Torgal and Labrincha (2013) highlighted that one of humanity's strangest characteristics is that it consumes a massive quantity of resources, including non-renewable ones, leaving signs of pollution in the process. Most resources are consumed by only a few nations. This implies that when most of the population can afford the same consumption habits, the process will deteriorate. Every year, humanity consumes nearly 60 billion tonnes (Gt) of resources (Krausmann et al., 2009). The most serious environmental danger connected with its production is not the decline of non-renewable raw materials Allwood et al (2011), but rather the environmental consequences of its extraction, namely widespread deforestation, and top-soil loss. Therefore, there is a need for new and innovative construction material or alternate material in order to tackle this issue. Alternative construction materials are those that can be used cheaply instead of traditional building materials. Alternative construction components are produced from waste goods, which reduces environmental pollution. These alternative construction materials can be used if they satisfy the requirements outlined in the code of practise.

"Necessity is the mother of invention," as the adage goes. It is a desire for a better existence compelled us to create safer and better living circumstances that offer dependability, durability, and functionality (Bamigboye et al., 2019). Sustainability, longevity, dependability, safety, cost reduction, improved quality, better mechanical and physical features, severe condition adaptability, easy assembly, and environmental friendliness should all be factors in the acceptance of novel building materials (Andrade et al., 2018). These description fits the honeycomb shaped sandwiched material with natural fibre based composite material.

Sandwich constructions are lightweight materials with significant rigidity and a high strength-to-weight ratio. The sandwich panel's primary idea is that the outer portions transmit bending loads (flexural load and compression), while the centre transfers shearing loads. As a result, the macroscopically stated operation method of the sandwich panel can be accurately compared to I-beam (Krzyżak et al., 2016). A typical sandwich structure composite material (Fig. 1) consists of two thin face sheets with high stiffness and a comparatively soft-porous core (Yuan et al., 2015; Zhao et al., 2021). Sandwich structures have been found to have enormous potential for impact resistance due to their low weight, high specific strength and stiffness, and outstanding energy absorbing capability, and are widely used in various engineering domains such as aviation, aerospace, shipbuilding, and automobiles (Yuan et al., 2015).

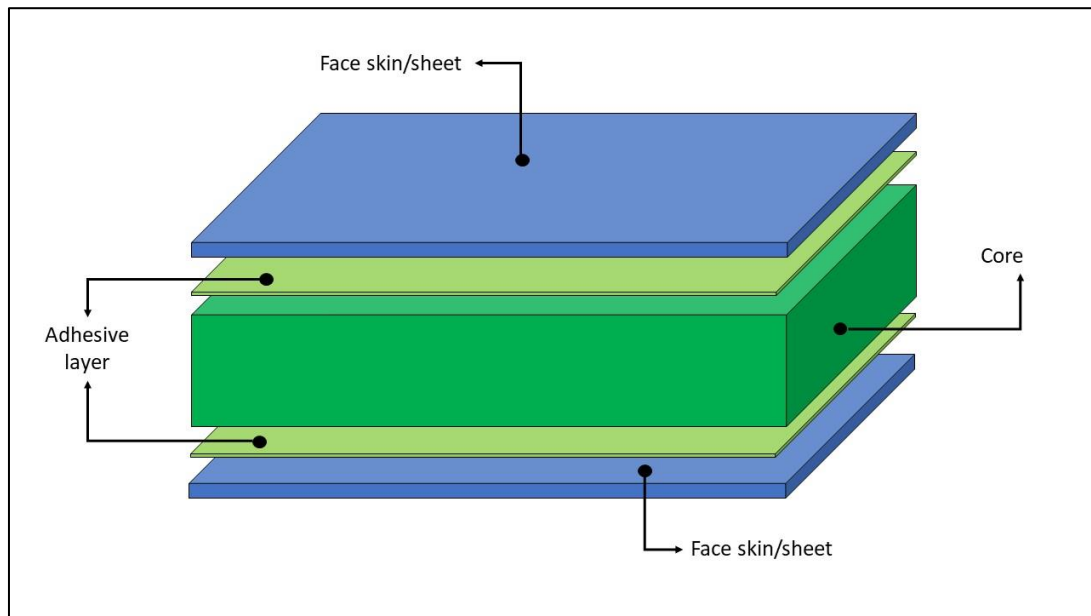

Fig. 1. Diagram of sandwiched structure composite material.

Source: Al-Azad

Honeycomb sandwich structures are structures in the form of a sandwich that comprise of two face sheets and a honeycomb centre between the sheets. Its primary application is to attain high stiffness-to-weight and strength-to-weight ratios. The frequency of sandwich panels is compounded by the fact that it rises exponentially for the first three values of thickness before coinciding with a set frequency for a higher value of thickness. One form of honeycomb sandwich construction is made up of three parts: glass fiber, carbon fiber, and aluminium 5052 (Upreti et al., 2020; Rayhan et al., 2022). The top and bottom sheet plates are made of metal and nonmetal materials, and the honeycomb sandwich construction can be made of a variety of materials such as metal, ceramic, and composite materials (Audibert et al., 2019). Currently, most of the sandwich structure material is composed of two hard metallic thin face sheets as well as a low density soft centre which is not suitable to be used as environmentally friendly material. Therefore, a natural fibre based honeycomb material is deemed to be suitable to be considered as alternative construction material.

An analysis by Al-Azad et al (2021) and an experimental research by Li and Ma (2020) discovered that three important variables affect flexure properties: sheet thickness, core height, core orientation, and core design. Among these, the thickness of the sheet has the greatest influence on the bending characteristics. The study of Li and Ma (2020) deduced that a thicker sheet exhibits higher flexural strength because of the properties of the sheet which is dense therefore, more force is required at the initial stage for the material to go beyond the elastic point. A similar explanation was given for core height where a longer core height is capable to absorb the energy from the force exerted and the material is mostly elastic at initial stage.

The effect of core shape on the sandwich structure composite was tested by (Arora and James, 2016). Their study was a comparison of circular core against hexagonal core through computational simulation. The results revealed that circular core has a relatively higher flexural stiffness than hexagonal core. Similar study was conducted by Hamzah et. al (2020) where a rectangular and triangle core was used to compare the flexural strength of the sandwiched structure material. It was found that the rectangular core exhibited a higher

flexural strength than the triangle core. Both of this study pointed that this is due to energy absorption capability of the core shape with respect to the area on volume of the core.

A thorough literature study has shown that honeycomb structures outperform other sandwiched structure material due to their greater energy absorption capacity (Thomas & Tiwari, 2018). Currently, these structures are extensively used in aeroplanes and aircraft, rocket substructures, military ships, racing vehicles, the automobile industry, and satellites due to their better properties (Thomas & Tiwari, 2018; Galehdari & Khodarahmi, 2016; Al-Azad et. al., 2021). However, the application of honeycomb sandwiched structure material does have a promising potential in the construction industry due to its high strength in terms of flexural strength which can be used as flooring panel.

## Methodology

### Material Description

A hexagonal honeycomb shaped sandwiched panel was used in this research. The face layer of the components was made of cement fiber, which is a composite material composed of cement, mortar, or concrete combined with discrete, evenly dispersed discontinuous fibre. Wood pulp, maize starch, and glycerine were used to make the central substance. The primary component is wood pulp, with maize starch acting as a binding agent and glycerine as a hardener for the core's surface.

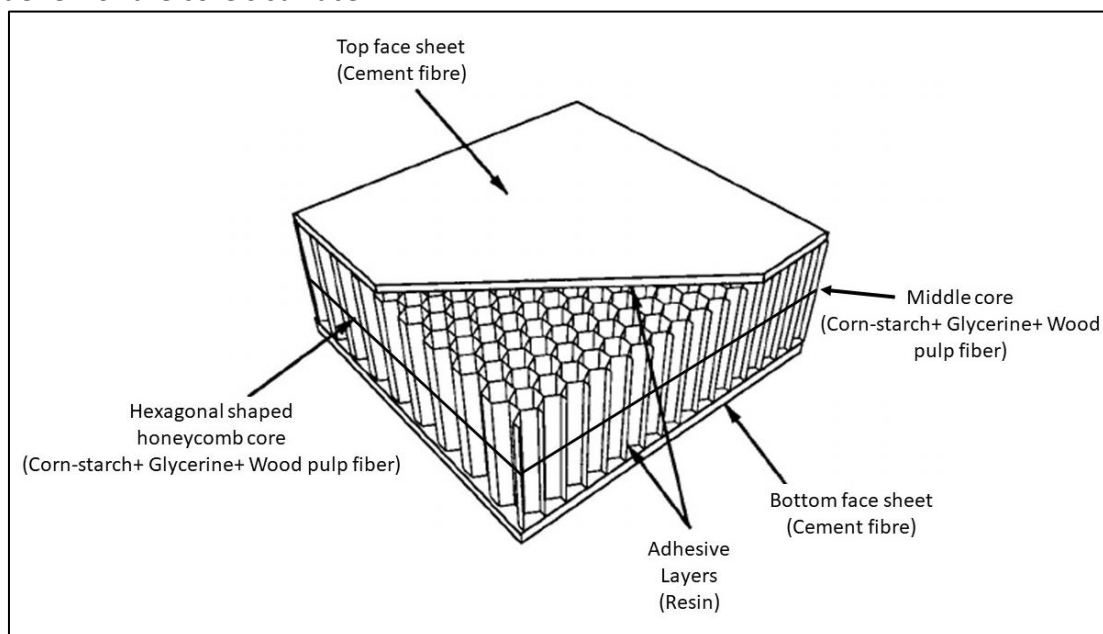

Fig. 2. Schematic of material.

Source: Modified from Yuan et. al (2015)



Fig. 3. Actual material.

Source: Image by Al-Azad

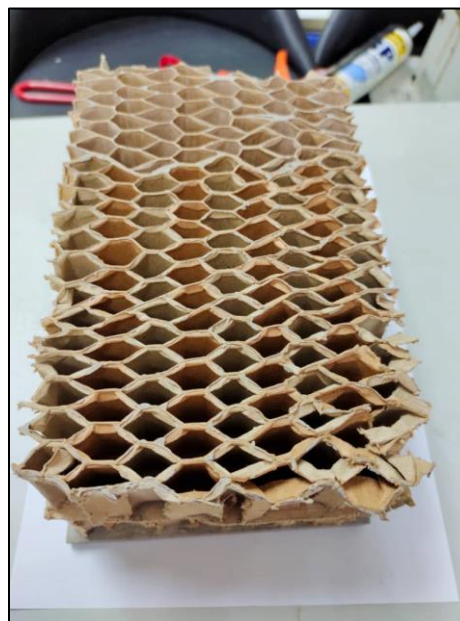

Fig. 4. Core details of the material.

Source: Image by Al-Azad

### Material Preparation

The material used was prepared according to the ASTM D7249 standard. The ASTM D7249 standard requires the preparation of seven samples. This indicates that in order to obtain the flexural properties of the material, the material should obtain 7 different flexural test readings. Each sample has a length of 640mm and a width of 300mm, as indicated in Figure 5 below. An angle grinder was used in order to cut the samples into the final dimensions (Figure 6). Each sample has been assigned a unique code: S1, S2, S3, S4, S5, S6, and S7.



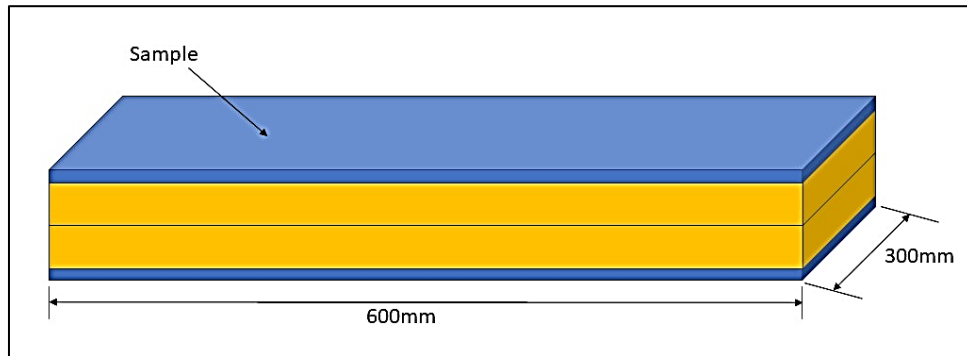

Fig. 5. Sample dimension



Fig 6. Samples after cut into final dimension

### Experimental Procedure

To study the flexural performance of the honeycomb sandwiched composite material, ASTM D7249 was employed where a 3-point bending test was conducted on Universal Tester Machine (UTM). A drive speed of 5mm/min was used as recommended by the standard. The universal tester machine gradually increases the load over time until a maximum break force (Fig. 9).



Fig. 7. Schimadzu Universal Tester Machine.

Source: Image by Al-Azad

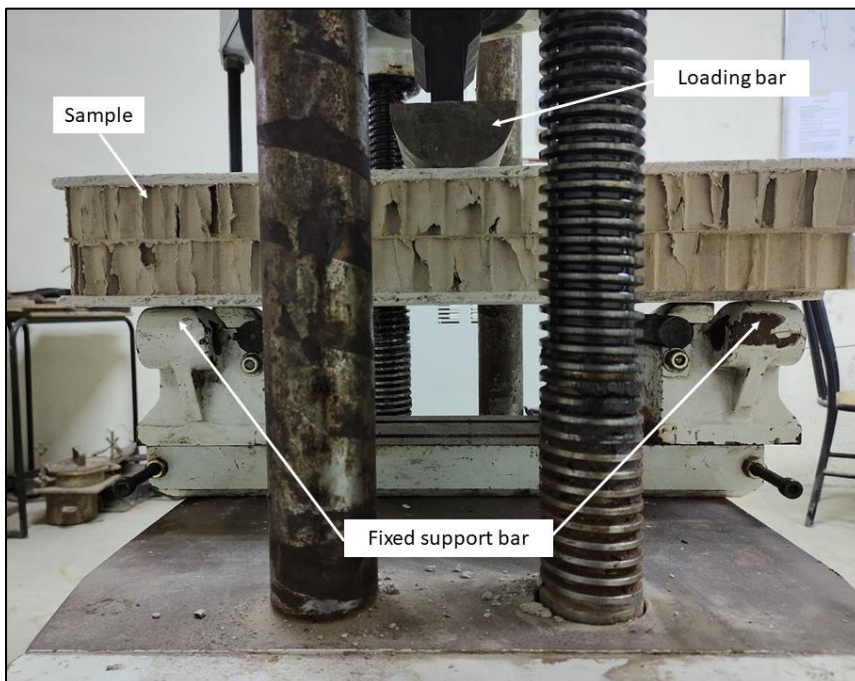

Fig. 8. Sample loaded on the UTM.

Source: Image by Al-Azad



Fig. 9. Sample achieved maximum break force.

Source: Image by Al-Azad

After the force-displacement curve was obtained from the 3-point bending test, a fractography analysis by the aid of an optical microscope with magnification between 10x-200x was performed according to the ASTM Standard C1322 to understand the causes of failures.

## Results & Discussion

### Flexural Test

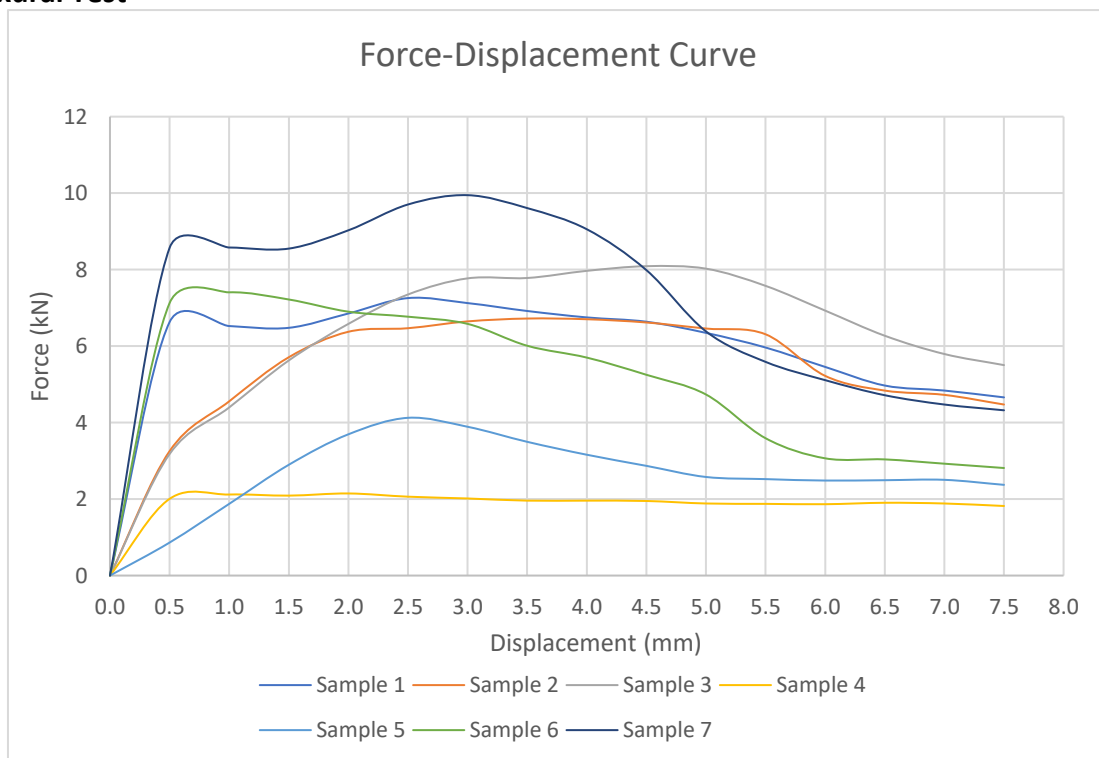

Figure 10. Force-displacement curve of all 7 samples.



Figure 10 above shows the obtained force-displacement curve of all the 7 samples. Based on this curve, sample 1, 4 and 7 shows a similar curve compared to sample 6 and sample 5. Meanwhile sample 2 and 3 shows a similar trend. The variation in results across samples with comparable force-displacement curve trends but differing failure output trends has motivated additional investigation into this topic. Samples 2 and 3 had a comparable force-displacement curve, implying that no core folding occurred (Figure 11a), however sample 3 did display core folding (Figure 11b). Similarly, samples 1, 4, and 7 showed the same force-displacement curve trend, with core folding occurring after the maximum safe load was reached but with a full crack (Figure 11c); however, sample 7 showed a failure outcome similar to samples 5 and 6, indicating no core failure but a hairline crack on the face sheet only (Figure 11d). The fundamental reason of these disparities was discovered to be varying core packing factor, manufacturing irregularity, poor core density, and low fibre content.

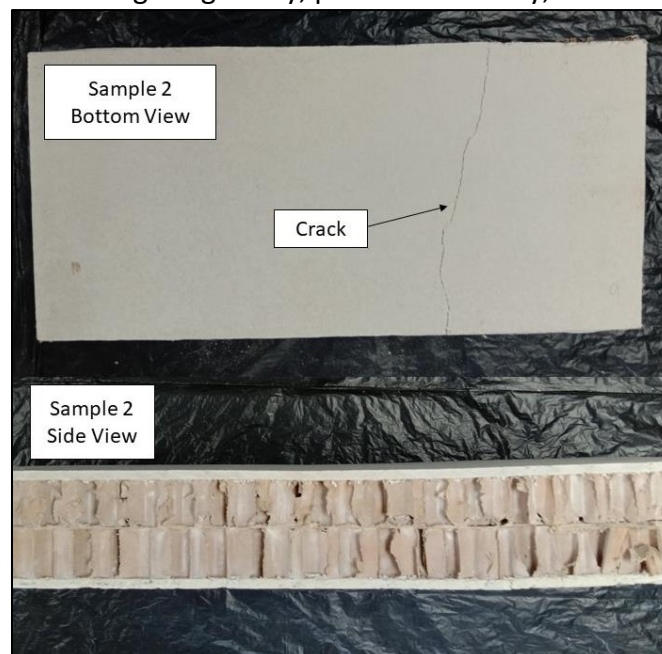

Figure 11a. Sample 2 showing no core folding occurred

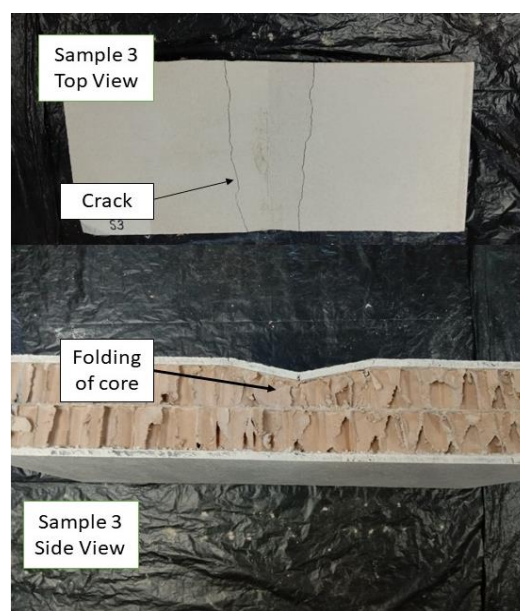

Figure 11b. Sample 3 displaying core folding

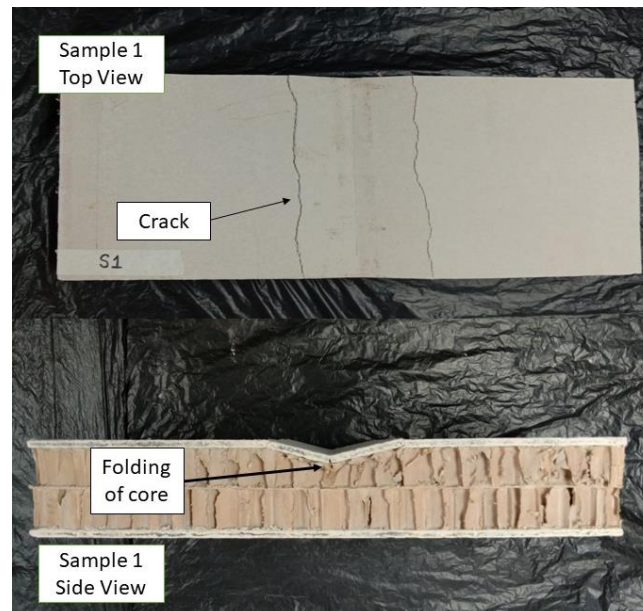

Figure 11c. Sample 1 displaying full crack and folding of core

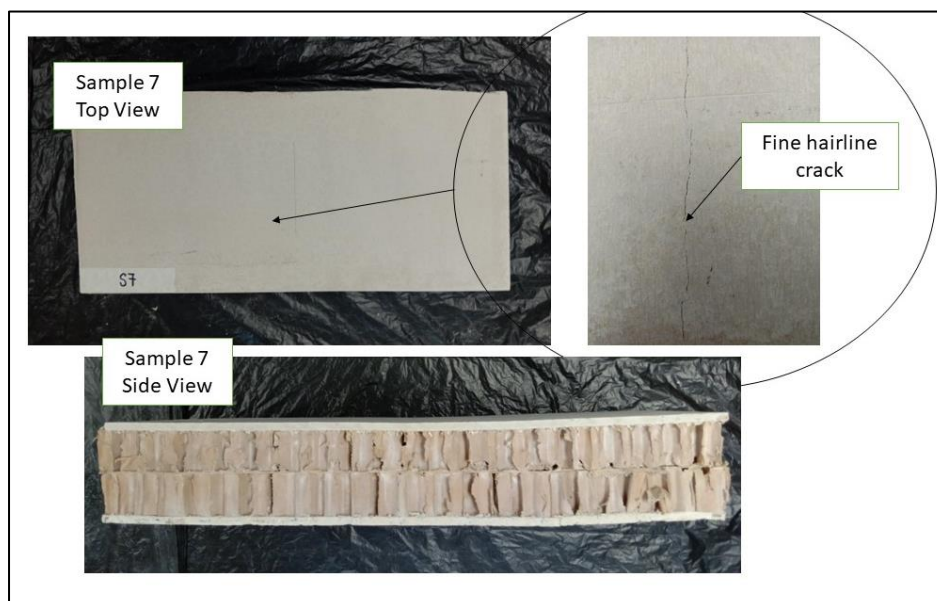

Figure 11d. Sample 7 displaying hairline crack with no core failure.

As honeycomb constructions are highly sensitive, certain connections may be damaged or separated for a number of reasons during manufacturing or while cutting the sandwich structure, causing issues later in their life cycle (Wang et al., 2018). According to Wang et al. (2018), one of the most common defects in honeycomb constructions is the irregularity of the cells that formed during the manufacturing stage. Manufacturing defects have an influence on the overall performance of the honeycomb structure. They impair the mechanical operation of the honeycomb structure. Minor faults induced by inhomogeneous sections will impede deformation and render the sandwich structure structurally unstable (Wang et al., 2018). This statement was found to be true during the fractography analysis conducted and shown in Figure 14a below where dimple was found. As a result, the face sheet crack was observed as indicated in Figure 11c.

Another possible contributor to these events is low core density. Ideally all of the samples are from the same panel, therefore the core density is assumed to be the same all across the panel. Figure 12, on the other hand, clearly shows that the core packing for these specific samples is not homogenous. The thickness and density of the core cell may have changed because certain cells in the core were jammed together while others were split apart. This might be due to a manufacturing flaw that happened during the fabrication process (Wang et al., 2018).

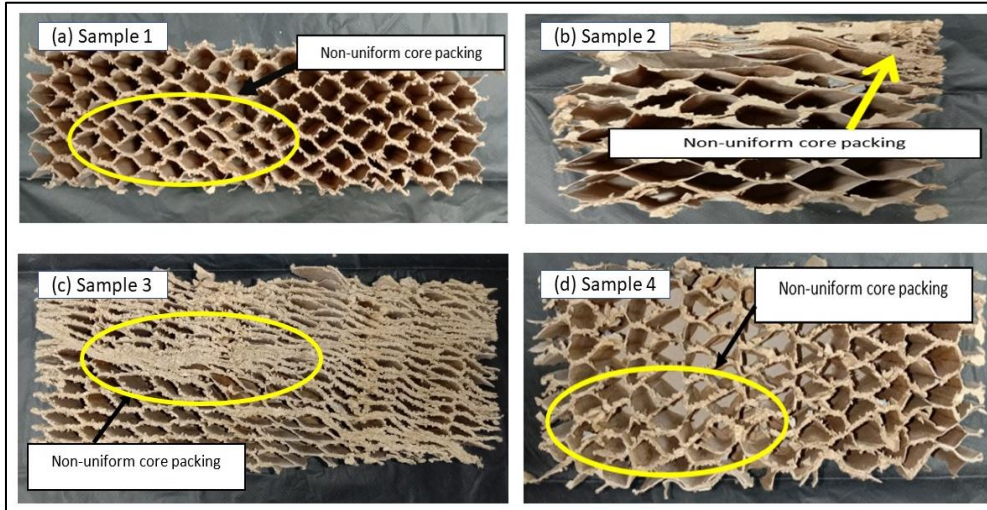

Figure 12. Core packing (a) sample 1, (b) sample 2, (c) sample 3, and (d) sample 4

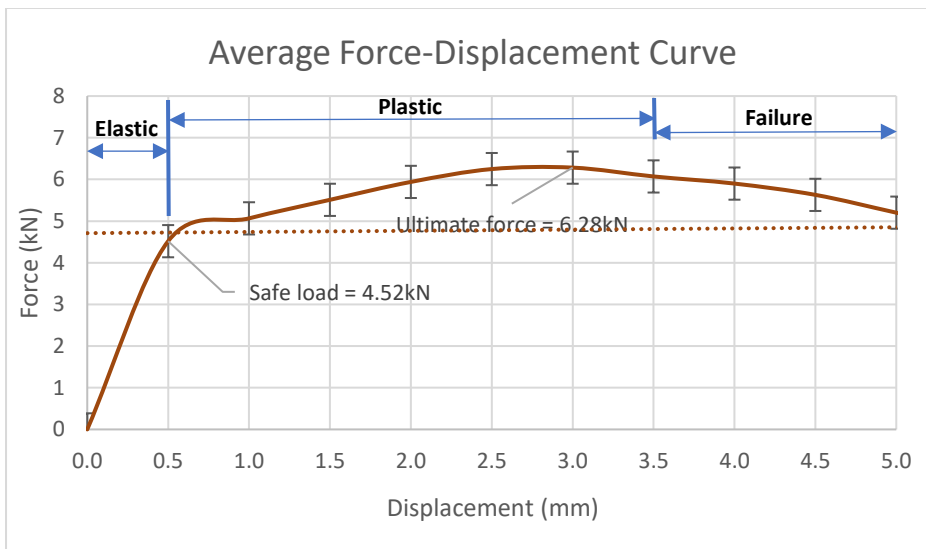

Fig. 13. Average flexural profile of the material.

Source: Al-Azad

The analysis of the average force-displacement graph presented in Fig. 13 provides valuable insights into the flexibility characteristics of the material under investigation. In a study by Smith et al (2019), the authors emphasize the importance of the ASTM standard for evaluating material flexibility. The ASTM standard suggests using the average curve as the actual curve, as it provides a representative characterization of the material's behaviour. This approach allows for a comprehensive understanding of the material's response to applied forces. Examining Fig. 13 in detail, it is evident that the material exhibited linear elasticity up to a deflection of 0.5mm when subjected to a maximal load of 4.52kN. This finding is consistent

with the work of Johnson and Thompson (2018) where they describe the linear elasticity rule, which states that a material will behave elastically and return to its original shape as long as the applied forces remain within the material's elastic limit.

Beyond 0.5mm deflection, the material transitioned into the plastic phase, as depicted in Fig. 13. Plastic deformation refers to the permanent change in shape that occurs in a material when it is subjected to a load exceeding its elastic limit. In the case of the analysed material, plastic deformation took the form of core folding. This observation aligns with the findings of Chen et al (2020) in their study. They discuss how various materials can undergo different modes of plastic deformation, such as folding, shearing, or cracking, depending on their composition and structural characteristics.

The force-displacement graph in Fig. 13 reveals that the folding of the material's core initiated at the upper core and progressed until the core ultimately fractured at a maximum force of 6.28kN, occurring at 3.0mm deflection. This behaviour highlights the material's limited ductility, as it experienced plastic deformation before reaching its breaking point. Ductility refers to a material's ability to deform plastically under stress without fracturing. The general curve profile of the substance, as indicated in the graph, signifies its overall ductility. To further support the analysis, additional studies by Liu et al (2017) and Wang et al. (2018) discussed the significance of understanding a material's ductility and its relation to failure mechanisms.

In conclusion, Fig. 13 and the accompanying analysis illustrate the material's flexibility characteristics. It adhered to the linear elasticity rule until a deflection of 0.5mm, after which plastic deformation occurred in the form of core folding. The material displayed limited ductility, ultimately leading to core fracture at a maximum force of 6.28kN and 3.0mm deflection. These findings are consistent with prior research in the field and contribute to a comprehensive understanding of the material's mechanical behaviour.

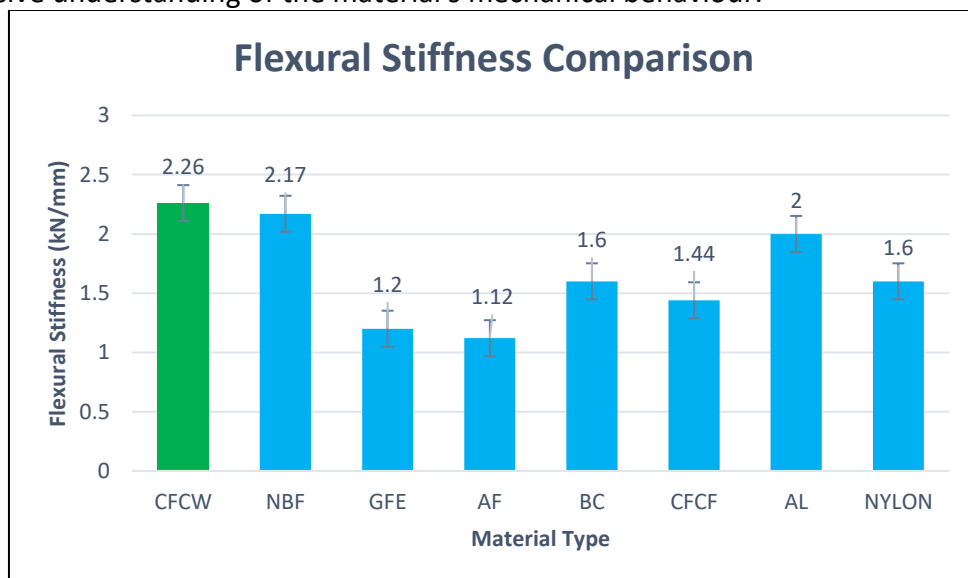

Fig. 14. Comparison of the material with other honeycomb materials.

Source: Al-Azad

According to Fig. 14, the mixture of cement fibre and corn starch combined with wood pulp fibre (denoted by CFCW) used in this study appears to have the highest flexural stiffness when compared to other materials. The flexural stiffness of the Nomex-Basalt Fiber (NBF) sandwiched construction used by Li and Ma (2020), which employs a honeycomb centre, was



found to be similar to that of the CFCW material used in this study. The lowest flexural stiffness was discovered in the Glass Fibre Epoxy (GFE) material by Bahabadi et al., (2020) and the Aluminium-Foam (AF) sandwiched material by Mirzamohammdi et al., (2022). This implies that brittle materials have lower bending stiffness than ductile materials.

Brittle materials, such as pure aluminium (AL) and nylon, were found to have slightly greater flexural rigidity than other brittle sandwiched construction materials in the research of (Harland et al., 2019). According to Harland et al.'s (2019) research, this disparity is due to distinct production processes producing varying flexural stiffness outcomes. For example, Harland et al (2019) material used 3D printing method, the research compared with corrugated method sandwiched structure production, and the difference was obvious. Mouka et al.'s (2020) Bamboo Culm (BC) material and Safaei et al.'s (2020) Carbon Fibre-Carbon Foam (CFCF) layered material were found to be lower than among flexible materials.

### Fractography Analysis

An optical microscope was used to study the fracture propagation and morphology of the surface structure of a sandwich made of natural fibre honeycomb. The development of a single macroscopic crack does not always induce the fractionation of these structures.

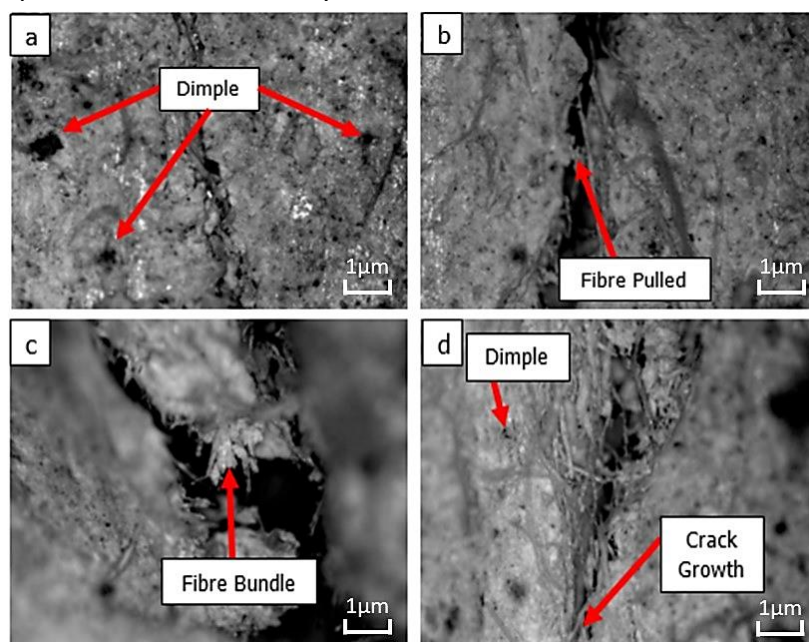

Fig. 15. Sample under optical microscope with 5x magnification

Source: Image by Al-Azad

Fig. 15 (a) shows several gaps and dimples on the face sheet's surface. There are dimples in the region where the fracture first appeared. Fig. 15 (a) and throughout show dimples and fissures on the split surface. Surface cracking is evident in Fig. 15 (a), as evidenced by the lines. Fig. 15 (b) and (c) show a set of fibre bundles that were found to be fractured, as well as a set of fibres that had drawn away from matrix bonding due to weak interfacial bonds. (Lee et al., 2021; Wang et al., 2019). Fig. 15(d) shows how the dimple can be seen inside the fibre while the crack propagates on the exterior. The creation of discrete ledges or steps across crystallographic planes by cleavage fractures, frequently with river patterns that aid metallurgists in determining the direction of crack spread. (Pantazopoulos 2019). The quantity and density of fibre pull-out sites in Figs 15 (b) and 15 (c) can be used to assess how

well an interface performs in terms of strength. As a consequence, the composites had weak bonds with one another and were readily detachable, resulting in a low density sample. (Ketoja et al., 2019).

The breakage at the fibre-matrix surface that causes the fibre to be torn out under additional pressure is referred to as fibre pulled out Fig. 15(b). (Khieng et al., 2021). With increased loading, the energy stored within individual stretching bridging fibres will ultimately hit a crucial level, resulting in fibre failure. If a fibre fails along its entire length revealed within the crack flanks, it is rendered dormant in terms of load input. If, on the other hand, the fibre fails along the debond length, it will pull-out (Gabriel et al., 2022). The energy spent as friction at the contact is the pull-out mechanism's input to the energy dissipation capacity of the composite.

Mechanical crack as seen in Fig. 15(d) occurs when atomic or molecule bonds separate. It can be brittle or ductile depending on the quantity of tension present at the moment of breakage. (Wu, 2018). Brittle elements, such as rock, concrete, glass, and cast iron, show this property. Prior to fracture, the substance has experienced substantial plastic deformation, which is referred to as a ductile fracture. The fracturing of flexible metals such as soft steel, rubber, and plastics is known as ductile fracture. The matrix without fibre in this substance was found to be fragile or ductile based on the sample. It readily fractures due to poor interfacial bonding between the matrix, which is typically found in matrix rich areas or between fibre tracks (Hayes et al., 2015).

## **Conclusion**

The analysis of the study's results provides significant information about the material's behaviour and its potential use as a construction material. The maximum weight that the material can sustain without failing was determined to be 4.52kN, accompanied by a maximum deflection of 0.5mm. With a measured stiffness of 2.26 kN/mm, the material can resist deformation and is categorized as ductile. The findings confirm the theory that poor interfacial bonding between the fibre and matrix can result in failures within both components. The observed failures of the fibre and matrix highlight the importance of strong interfacial bonding in composite materials. In this study, the samples were intentionally left untreated to simulate real-life conditions and to capture any surface defects that might be present. This approach allows for a more realistic assessment of the material's performance in practical construction applications. By examining the failure modes under untreated conditions, the study provides insights into potential weaknesses and informs strategies for improving the material's performance. The variation in the number of failures observed on the samples can be attributed to the fluctuating orientation of the fibre and matrix, indicating the need for better control over the distribution of reinforcing fibres. Incorporating fibre-reinforced cement face sheets has the potential to enhance the material's resilience. However, it is crucial to improve the interfacial contact between the fibre and matrix, which can be achieved through fiber treatment methods to optimize fibre directionality. Overall, this research sheds light on the material's load-bearing capacity, stiffness, and failure mechanisms, emphasizing the significance of interfacial bonding in composite materials. By considering real-life conditions and addressing factors such as surface defects and fibre orientation, this study contributes to a comprehensive understanding of the material's behaviour in practical applications. It suggests that incorporating fiber-reinforced cement face sheets and optimizing the fibre-matrix interfacial contact can further enhance the material's performance and resilience.

**References**

- Pacheco-Torgal, F., & Labrincha, J. A. (2013). The future of construction materials research and the seventh UN Millennium Development Goal: A few insights. *Construction and Building Materials*, 40, 729–737. <https://doi.org/10.1016/j.conbuildmat.2012.11.007>
- Allwood, J. M., Ashby, M. F., Gutowski, T. G., & Worrell, E. (2011). Material efficiency: A white paper. *Resources, Conservation and Recycling*, 55(3), 362–381. <https://doi.org/10.1016/j.resconrec.2010.11.002>
- Bamigboye, G. O., Davies, I., Nwanko, C., Michaels, T., Adeyemi, G., & Ozuor, O. (2019). Innovation in Construction Materials-A Review. *IOP Conference Series: Materials Science and Engineering*, 640(1), 012070. <https://doi.org/10.1088/1757-899x/640/1/012070>
- de Oliveira Andrade, J. J., Possan, E., Squiavon, J. Z., & Ortolan, T. L. P. (2018). Evaluation of mechanical properties and carbonation of mortars produced with construction and demolition waste. *Construction and Building Materials*, 161, 70–83. <https://doi.org/10.1016/j.conbuildmat.2017.11.089>
- Krzyżak, A., Mazur, M., Gajewski, M., Drozd, K., Komorek, A., & Przybytek, P. (2016). Sandwich Structured Composites for Aeronautics: Methods of Manufacturing Affecting Some Mechanical Properties. *International Journal of Aerospace Engineering*, 2016, 1–10. <https://doi.org/10.1155/2016/7816912>
- Yuan, J., Chen, X., Zhou, W., & Li, Y. (2015). Study on quasi-static compressive properties of aluminum foam-epoxy resin composite structures. *Composites Part B: Engineering*, 79, 301-310.
- Zhao, Y., Yang, Z., Yu, T., & Xin, D. (2021). Mechanical properties and energy absorption capabilities of aluminium foam sandwich structure subjected to low-velocity impact. *Construction and Building Materials*, 273, 121996.
- Upreti, S., Singh, V. K., Kamal, S. K., Jain, A., & Dixit, A. (2020). Modelling and analysis of honeycomb sandwich structure using finite element method. *Materials Today: Proceedings*, 25, 620–625. <https://doi.org/10.1016/j.matpr.2019.07.377>
- Rayhan, S. B., Chowdhury, M. U., & Pu, X. (2022). Ballistic impact response of reinforced honeycomb sandwich panels. *IOP Conference Series: Materials Science and Engineering*, 1226(1), 012079. <https://doi.org/10.1088/1757-899x/1226/1/012079>
- Audibert, C., Andréani, A.-S., Lainé, É., & Grandidier, J.-C. (2019). Discrete modelling of low-velocity impact on Nomex® honeycomb sandwich structures with CFRP skins. *Composite Structures*, 207, 108–118. <https://doi.org/10.1016/j.compstruct.2018.09.047>
- Al-Azad, N., Mojutan, E. C., & Shah, M. K. M. (2021). A Mini Review on Natural Fiber Honeycomb (NFH) Sandwiched Structure Composite: Flexural Performance Perspective. *Journal of Materials Science and Chemical Engineering*, 09(05), 1–10. <https://doi.org/10.4236/msce.2021.95001>
- Li, Z., & Ma, J. (2020). Experimental Study on Mechanical Properties of the Sandwich Composite Structure Reinforced by Basalt Fiber and Nomex Honeycomb. *Materials*, 13(8), 1870. <https://doi.org/10.3390/ma13081870>
- Arora, S. P. S., and James, N. R. (2016) Study the Effect of Core Design on Mechanical Behaviour of Honeycomb Sandwich Structures under Three Point Bending. *International Journal of Innovative Research in Science, Engineering and Technology*, 5, 9444-9449.
- Hamzah, A. F., Al-Kawaz, A. E., & Hamzah, A. S. (2020). Effect of Cell Shape on Flexural Strength of Honey Comb Structure. *Test Engineering and Management*, 83, 14982–14991.

- Thomas, T., & Tiwari, G. (2019). Crushing behavior of honeycomb structure: a review. *International Journal of Crashworthiness*, 24(5), 555-579.
- Galehdari, S. A., & Khodarahmi, H. (2016). Design and analysis of a graded honeycomb shock absorber for a helicopter seat during a crash condition. *International journal of crashworthiness*, 21(3), 231-241.
- Al-Azad, N., Asril, M. F. M., & Shah, M. K. M. (2021). A review on development of natural fibre composites for construction applications. *Journal of Materials Science and Chemical Engineering*, 9(7), 1-9.
- Bahabadi, H. M., Farrokhabadi, A., & Rahimi, G. H. (2020). Investigation of debonding growth between composite skins and corrugated foam-composite core in sandwich panels under bending loading. *Engineering Fracture Mechanics*, 230, 106987.
- Mirzamohammadi, S., Eslami-Farsani, R., & Ebrahimnezhad-Khaljiri, H. (2022). The characterization of the flexural and shear performances of laminated aluminum/jute–basalt fibers epoxy composites containing carbon nanotubes: As multi-scale hybrid structures. *Thin-Walled Structures*, 179, 109690.
- Harland, D., Alshaer, A. W., & Brooks, H. (2019). An experimental and numerical investigation of a novel 3D printed sandwich material for motorsport applications. *Procedia Manufacturing*, 36, 11-18. doi:10.1016/j.promfg.2019.08.003
- Lee, C. H., Khalina, A., & Lee, S. H. (2021). Importance of interfacial adhesion condition on characterization of plant-fiber-reinforced polymer composites: A Review. *Polymers*, 13(3), 438. doi:10.3390/polym13030438
- Wang, F., Lu, M., Zhou, S., Lu, Z., & Ran, S. (2019). Effect of Fiber Surface Modification on the Interfacial Adhesion and Thermo-Mechanical Performance of Unidirectional Epoxy-Based Composites Reinforced with Bamboo Fibers. *Molecules*, 24(15), 2682. <https://doi.org/10.3390/molecules24152682>
- Pantazopoulos, G. (2019) "A short review on fracture mechanisms of mechanical components operated under industrial process conditions: fractographic analysis and Selected Prevention Strategies," *Metals*, 9(2), p. 148. Available at: <https://doi.org/10.3390/met9020148>.
- Ketoja, J., Paunonen, S., Jetsu, P., & Pääkkönen, E. (2019). Compression Strength Mechanisms of Low-Density Fibrous Materials. *Materials*, 12(3), 384. <https://doi.org/10.3390/ma12030384>
- Khieng, T. K., Debnath, S., Liang, T. C. E., Anwar, M., Pramanik, A., & Basak, A. K. (2021). A review on mechanical properties of natural fibre reinforced polymer composites under various strain rates. *Journal of Composites Science*, 5(5), 130.
- Gabriel, S., Langdon, G. S., von Klemperer, C. J., & Yuen, K. S. C. (2022). Blast behaviour of fibre reinforced polymers containing sustainable constituents. *Journal of Reinforced Plastics and Composites*, 07316844211072529.
- Wu, J. (2018). Material Interface of Pantograph and Contact Line. *Pantograph and Contact Line System*, 165–191. <https://doi.org/10.1016/b978-0-12-812886-2.00005-7>
- Hayes, M., Edwards, D., & Shah, A. (2015). *Fractography in failure analysis of polymers*. William Andrew.
- Wang, Z., Li, Z., Zhou, W., & Hui, D. (2018). On the influence of structural defects for honeycomb structure. *Composites Part B: Engineering*, 142, 183–192
- Chen, J., Zhang, Y., & Lee, S. (2020). Plastic Deformation Mechanisms in Core Materials. *Journal of Materials Science*, 55(8), 3269-3282.



Liu, H., Smith, R., & Johnson, T. (2017). Ductility and Fracture Behavior of Materials. *Journal of Mechanical Engineering*, 42(3), 187-200.

Smith, A., Thompson, L., & Williams, M. (2019). Mechanical Properties and Flexibility Analysis of Materials. *Materials Science Journal*, 25(4), 1025-1036.