

A Review of Technologies and Techniques for Indoor Positioning Systems

Zahariah Manap, Azmi Awang Md Isa, Abdul Majid Darsono,
Suraya Zainuddin

Centre for Telecommunication Research and Innovation (CeTRI), Fakulti Teknologi dan
Kejuruteraan Elektronik dan Komputer, Universiti Teknikal Malaysia Melaka

Corresponding Author Email: azmiawang@utem.edu.my

To Link this Article: <http://dx.doi.org/10.6007/IJARBS/v15-i2/24735> DOI:10.6007/IJARBS/v15-i2/24735

Published Date: 07 February 2025

Abstract

Location-based services are among important applications in current telecommunication networks which causes an increasing demand in the advancements of indoor positioning systems (IPS). This paper presents a comprehensive review of the technologies and techniques employed in recent works related to IPS and discusses the challenges in IPS implementations. This study widely categorizes indoor positioning technologies into five types which are computer vision, short-range communication, acoustic-based, magnetic methods, and radio frequency (RF) technologies. The strengths and limitations of each technology is discussed based on its accuracy, coverage, infrastructure, implementation cost and signal characteristics. The literature study shows that range-based and fingerprinting are two main techniques employed in IPS. In addition, the study indicates that fingerprinting methods utilizing Wi-Fi and cellular networks are prevalent due to their widespread availability. However, these technologies face some challenges such as multipath fading, signal instability, device heterogeneity, infrastructure and cost implications, computational complexity, and privacy and security concerns. This paper emphasizes the need for innovative approaches to enhance positioning accuracy and reduce infrastructure costs, thereby fostering broader adoption of IPS across diverse applications.

Keywords: Indoor Positioning Systems, RF Positioning, Location-Based Services

Introduction

The increasing demand for advanced location-based services within modern telecommunication networks is a direct result of the growing access to information in both outdoor and indoor settings. This surge in demand is further propelled by the ongoing development and standardization of fifth generation (5G) cellular communication systems, where a significant emphasis is placed on enhancing the precision of mobile station (MS) positioning within the network (3GPP, 2017). The accurate estimation of an MS's location and the continuous monitoring of its movement are essential for a multitude of applications, such

as vehicle navigation systems, child tracking devices, social networking tools, healthcare monitoring, transportation management, localized weather reporting, traffic updates, urban concierge services, automation industry applications, drone operations, assisted living technologies, and the burgeoning field of the internet of things (IoT). A variety of indoor positioning technologies and techniques have been proposed to provide efficient indoor positioning systems (IPS). These methods need to be specifically tailored to meet the sole requirements of different environments and applications. This paper reviews the technologies and techniques employed in recent works related to IPS and discusses several challenges in IPS implementation. The next section gives an overview of the technologies and techniques of IPS. Subsequently, a detailed discussion on IPS technologies and techniques is presented in separate sections. Finally, the paper outlines several challenges in IPS implementation that can serve as a reference for future research on IPS enhancement.

Overview of the Indoor Positioning Systems

The implementation and deployment of IPS lies in the user-oriented and environment-specific nature, which largely depends on the requirements of the users and the limitations of the environment. Developing suitable IPS is a challenging task due to the wide variety of indoor positioning technologies and principles, as well as the complex and dynamic nature of indoor environments. As discussed in the literature, the required indoor positioning accuracy is still yet to be achieved, and efforts on designing and developing optimal techniques that perform well under any indoor environment setting and circumstances are still ongoing (Guo et al., 2020; Subedi & Pyun, 2020; Zafari et al., 2019). Figure 1 presents a structured overview of the technologies, techniques, and corresponding parameters commonly employed in the implementation of IPS.

As shown in Figure 1, the technologies used in indoor positioning are broadly categorized into computer vision (optical-based), magnetic, acoustic-based (sound), short/medium communication, and radio frequency (RF). Computer vision, magnetic induction, and sound fall under non-radio frequency (non-RF) technologies commonly employed in IPS. Computer vision capitalizes visual features that are available in the environment to determine the location of objects or targets (Morar et al., 2020). Primarily, this technology employs feature detection and matching methods, which rely on the identification and correspondence of typical visual features such as natural objects in the environment or artificial tags captured by cameras or other optical sensors. On the other hand, magnetic induction methods leverage variations in the Earth's magnetic field to determine the location of targets within indoor environments. This technology typically involves the use of magnetometers to measure these magnetic field variations in the studied area. The most common approach in magnetic-based IPS is magnetic fingerprinting (Kwak et al., 2019; Y. Zheng et al., 2021), where a database of unique magnetic field signatures is created at various locations within the studied area. Sound-based IPS utilize various acoustic methods to determine the location of targets or objects within indoor environments. These systems typically employ either an active or passive sound-based approach. Active systems use sound signals that are intentionally emitted, such as ultrasound or audible sound waves, to calculate the Time-of-Flight (ToF) or time-difference-of-arrival (TDOA) between the emitter and the receiver (Delabie et al., 2023; Gualda et al., 2021). Passive systems, on the other hand, rely on ambient sounds that are naturally present

in the environment to create a fingerprint that can be used to identify specific locations (Tariq et al., 2017).

Visible light communication (VLC), infrared (IR), and Bluetooth Short are popular technologies used for short to medium range data communication. Surprisingly, these technologies have shown good potential as a signal source for IPS. VLC-based IPS utilizes the existing lighting infrastructure as the positioning signal sources for fingerprinting or range-based positioning approaches. In fingerprinting techniques, the unique flickering patterns of light emitting diodes (LEDs) are exploited to create fingerprints that act as distinct location identifiers. Meanwhile, range-based methods rely on the received signal strength (RSS) of light signals to calculate the distance between the LED source and the receiver (Zafari et al., 2019).

IR-based IPS commonly employ range-based approach, utilizing the time-of-flight (ToF) of the IR signal to estimate the distance between an IR emitter and a receiver (Maheepala et al., 2020). The same approach is often found to be used in Bluetooth-based IPS where the RSS from multiple Bluetooth beacons is captured and processed to estimate the position of a target (Abed et al., 2022).

Four key RF technologies used for indoor positioning are Ultra-Wide Band (UWB), Radio Frequency Identification (RFID), Wireless Fidelity (Wi-Fi), and cellular networks. RF-based indoor positioning technologies employ various methods including range-based, proximity sensing, and fingerprinting. UWB technology provides a wide spectrum of frequencies to transmit data, allowing for high-precision channel parameters measurement that is crucial in positioning accuracy (Djosic et al., 2021; Yu et al., 2019). RFID systems use RFID tags and readers to communicate and identify objects, with active and passive tags emitting or reflecting signals that can be used for positioning (Motroni et al., 2021). Both Wi-Fi and cellular technologies use the same resource allocation scheme, which is orthogonal frequency division multiplexing (OFDM). Wi-Fi based indoor positioning commonly employs fingerprinting by utilizing RSS. Cellular-based indoor positioning commonly employs range-based methods utilizing time, direction or RSS (X. Li, 2019; You & Wu, 2020), and fingerprinting (Chai et al., 2020; Rizk, 2019).

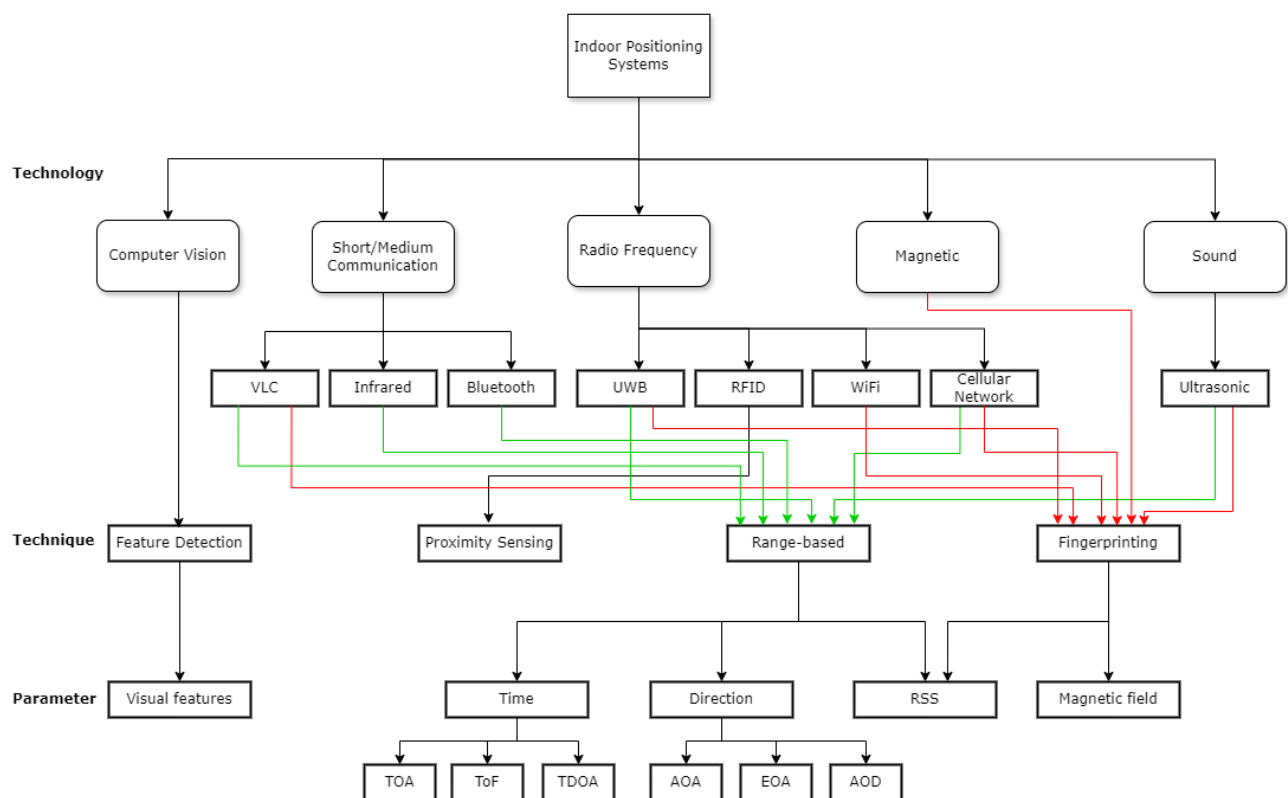

Figure 1: Technologies and techniques of IPS

The chart of Figure 1 apparently shows that range-based and fingerprinting are the most prominent techniques in IPS. These techniques are widely adopted across various IPS technologies. In terms of IPS technology, Wi-Fi and cellular networks emerge as the two most prominent technologies used, owing to their extensive availability in indoor environments. This is due to the advent of the modern wireless communication era and the demand for IoT services that led to the ubiquitous deployment of Wi-Fi infrastructure across a multitude of settings, including offices, homes, airports, restaurants, and shopping malls. This pervasive presence of Wi-Fi has facilitated the adoption of fingerprinting as a primary method for indoor positioning, which leverages the RSS of Wi-Fi signals. Concurrently, cellular networks have adapted to the increasing density of mobile users in indoor areas by introducing small cells technology, which enhances network capacity and coverage in confined spaces (Andrade et al., 2021; Fuschini et al., 2015). It is also worth to note that IPS utilizing optical, IR, and ultrasonic signals are resistant to multipath effects and offer relatively high accuracy. However, the IPS based on these technologies suffer from limitations such as lack of communication capabilities, reduced robustness, limited coverage, and difficulties in integration with other systems (Asaad et al., 2022; Morar et al., 2020; Seszyk et al., 2022). Conversely, RF-based IPS technologies, including Wi-Fi (Hernández et al., 2021; Zou et al., 2017), Bluetooth (Abed et al., 2022; Giuliano et al., 2020), UWB (Djosic et al., 2021; Jespersen et al., 2018), and RFID (Motroni et al., 2021), are more robust, feature a low setup cost, and are easily integrated with other systems.

Technologies for Indoor Positioning Systems

This section discusses various technologies employed in recent works of IPS, including magnetic, ultrasonic, VLC, Bluetooth, infrared, RFID vision, Wi-Fi, and RF technologies. In

addition, the advantages and challenges faced by these systems, such as signal instability and environmental interference are discussed.

Magnetic Field Induction

Magnetic-based IPS leverage the unique properties of magnetic fields, which are only influenced by ferromagnetic materials and are not reflected by mechanical surfaces. These fields do not require line of sight (LOS), are immune to multipath interference and fading, and necessitate low-cost transmitters and receivers, along with simple development setups. Magnetic field-based IPS can utilize either an artificial magnetic field (Kusche et al., 2021; K. Li et al., 2022; Y. Zheng et al., 2021), or the geomagnetic field (Abid et al., 2021; Antsfeld & Chidlovskii, 2021). Artificial magnetic-based applications need additional infrastructure to generate the magnetic field. On the contrary, the geomagnetic field approach employs the disturbances caused to the Earth's natural magnetic field by the indoor infrastructure. The utilization of geomagnetic field characteristics for indoor positioning offers notable advantages in terms of stability as the geomagnetic field is constantly present. The theoretical uniqueness of the geomagnetic field at any given point in near-Earth space adds an appealing feature, forming a robust foundation for IPS. The unique pattern of magnetic field allows many magnetic-based IPS to apply fingerprinting techniques based on geomagnetic field features to enhance accuracy (C. Huang et al., 2024). An illustration of the magnetic field variations in a building is shown in Figure 2.

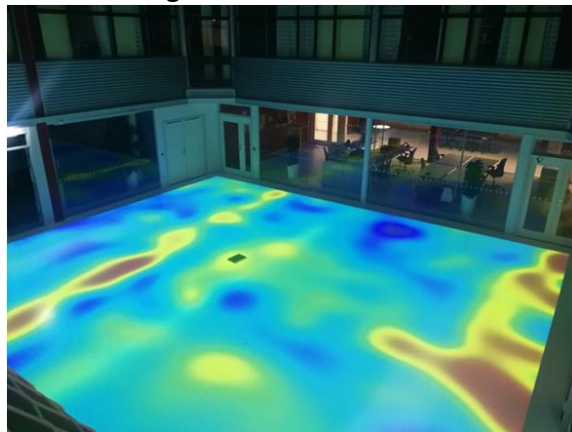

Figure 2: Illustration of the magnetic field in a building (C. Huang et al., 2024)

The geomagnetic magnetic field is subjected to certain limitations including its inherent non-uniformity, influenced by factors such as the building's construction and the presence of metal elements like electrical equipment. Additionally, in a long run, the reliability of geomagnetic field is affected by diurnal variations impact. Since the prominent positioning technique employed in magnetic-based IPS, the reference fingerprints must be remeasured whenever there are changes in the field distribution, especially due to the relocation of metal components within the indoor environment. This poses the challenge of the reliance on fingerprint database. In complex indoor environments, the range of magnetic fields is limited and can be attenuated or distorted by obstacles such as walls, furniture, and human bodies. This interference significantly impacts the reliability of magnetic field measurements. Moreover, magnetic field measurements are highly sensitive to the orientation and position of the sensing device. Even a minor change may result in significant variations, leading to errors in positioning estimation. Therefore, the development of accurate and robust indoor

positioning algorithms based on magnetic fields requires advanced signal processing techniques, including sensor fusion, filtering, and magnetic field modelling.

Ultrasonic

In ultrasonic-based IPS, high-frequency sound waves are utilized to estimate the location of targets or objects. These systems typically consist of an ultrasound emitter and receiver, which commonly combined into a single device. The system estimates the target's position based on the distance of sound wave traveled from the transmitter to the receiver, which basically done by measuring the time of arrival (TOA). One of the key benefits of the ultrasonic-based IPS is their non-line of sight (NLOS) capability, which allows for accurate positioning even when direct visual contact between the emitter and receiver is absent. This is particularly useful in environments with obstacles or in situations where maintaining a clear LOS is impractical. Additionally, these systems are relatively low cost, making them accessible for a wide range of uses, from consumer electronics to industrial applications. Furthermore, ultrasonic systems are known for their low power consumption, which is advantageous for battery-operated devices as it extends battery life and reduces the need for frequent recharging or replacement.

Despite these advantages, ultrasonic-based IPS also face several challenges including limited range of transmission, which restricts the positioning area. This constraint can be a barrier in large indoor spaces where extended coverage is necessary. Additionally, these systems are sensitive to environmental factors such as temperature, humidity, and air density that can affect the speed of sound, which is the main parameter that affects the TOA measurement. These systems also are prone to interference from other ultrasonic sources can disrupt the signal, causing inaccurate measurements. The development of ultrasonic-based IPS requires careful system design, calibration, and the implementation of advanced signal processing techniques to mitigate the impact of environmental factors and interference (Delabie et al., 2023; Gualda et al., 2021).

Visible Light Communication

VLC-based IPS operate under Lambert's emission law, incorporating both LOS and NLOS scenarios. These systems exploit the unique capabilities of LEDs to transmit data by modulating light intensity and frequency (Miramirkhani & Uysal, 2015; A. B. M. M. Rahman et al., 2020; Sarbazi et al., 2014). As depicted in Figure 3, the data transmission involves the process of modulating the light emitted by LEDs, which is then received by a photodetector or camera sensor on a user device, such as a smartphone. The modulated light carries information necessary for positioning, including the identifier and location of the LED fixture. Upon receiving the data, a positioning algorithm on the device interprets the unique identifiers of the LED fixtures and uses signal processing techniques to calculate the position. Common methods for position calculation include trilateration and triangulation. Trilateration estimates the user's position based on the ToF from multiple LED fixtures, while triangulation uses the angle of arrival (AOA) of the received signal. VLC-based indoor positioning can also implement fingerprinting techniques and proximity sensing for position estimation (Xie et al., 2018).

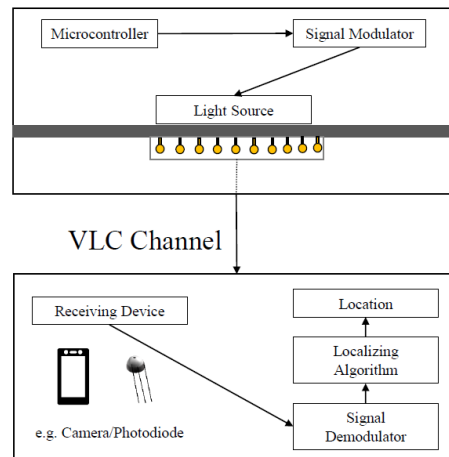

Figure 3: A basic concept of VLC-based indoor positioning (A. B. M. M. Rahman et al., 2020)

VLC-based IPS offer high throughput, and enhanced security due to confined light propagation across a short range (A. B. M. M. Rahman et al., 2020). Additionally, these systems are cost-effective because they leverage existing lighting infrastructure and remain imperceptible to the human eye due to rapid changes in visible light intensity. However, these systems are subjected to limited range, sensitivity to obstacles, and potential interference necessitate careful system design for accurate indoor positioning.

Bluetooth

Bluetooth is short-range communication that typically operates within a range of 10-15 meters. Despite its low-bandwidth capability, this technology offers a low-cost infrastructure. Therefore, Bluetooth is widely integrated into a variety of electronic devices commonly found in indoor settings, such as mobile phones, laptops, printers, watches, and earphones. The widespread adoption of Bluetooth in current short-range communication systems and its easy infrastructure setup make it a promising candidate for providing beacons for indoor positioning. Additionally, the advancements of the new Bluetooth standard offer high processing speed, facilitating easy and rapid RSS reading. Another advantage of Bluetooth chips is their low power consumption, which is particularly beneficial for battery-limited systems (Giuliano et al., 2020). Bluetooth low energy (BLE) technology, especially in the case of BLE beacons, does not have varying RSS regulations, making it a more stable choice for indoor positioning.

Bluetooth technology has several weaknesses that impede its performance in providing high accuracy for indoor position estimation. As a short-range communication system, Bluetooth offers limited coverage. Therefore, to necessitate a comprehensive indoor positioning coverage, a Bluetooth-based IPS requires a large number of Bluetooth beacon nodes (tags). In addition, since Bluetooth operates in the crowded 2.4 GHz frequency band, the signals are susceptible to interference, which affects the reliability of Bluetooth-based IPS. Since these systems rely on the number of anchors providing beacons, achieving high accuracy in fine-grained positioning requirements is challenging due to the low density of anchor nodes. This limitation is due to the coarse distance estimates typically provided by Bluetooth signal measurements, which are based on RSS or ToF.

Infrared

IR-based positioning is gaining popularity in the field of robotics due to its high accuracy, with some devices capable of achieving accuracy down to millimeters. This technology allows the system to simultaneously estimate the target's position and build a detailed map of the environment, making it widely implemented in simultaneous localization and mapping (SLAM) algorithms (Y. Yang et al., 2021; Zhou et al., 2022). IR-based IPS operate in LOS scenarios, where an emitter (LED) projects an IR light grid to an IR sensor, such as a photodiode or camera. A common method of position estimation used in this technology is triangulation, which involves analysing the angles and distances from multiple reference points (Alkhwaja et al., 2019; Maheepala et al., 2020).

Among the advantages of implementing IR technology in IPS is this technology offers simplicity, low weight, compact size, and immunity to interference. However, as it relies on LOS communication through light signals, its application is limited due to its poor penetration in obstructed scenarios. Moreover, it is sensitive to environmental factors such as sunlight and fluorescent lighting (J. Huang et al., 2023).

Computer Vision

Computer vision-based IPS involves the process capturing images or video frames through cameras that are either placed at known locations in the environment or carried by a mobile target as depicted in Figure 4. These systems locate and track the targets by combining image processing technique and images of features or surrounding structures within the positioning area (Morar et al., 2020). The position of the target is estimated based on landmarks available in the surrounding area, which can include artificial markers such as Quick Response (QR) codes and fiducial tags, or objects that are part of the environment (Morar et al., 2020; Yan et al., 2022).

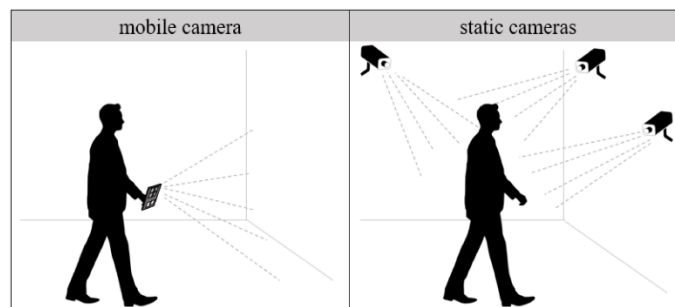

Figure 4: Illustration of a basic vision-based indoor positioning with (a) mobile camera, and (b) static cameras (Morar et al., 2020)

The high accuracy and real-time tracking capabilities offered by the computer vision-based IPS, provide the potential for seamless integration with augmented reality applications. The use of visual information allows for precise positioning and navigation in indoor environments. In addition, the adaptability and advancement of computer vision algorithms enable the recognition of diverse visual features, contributing to robust IPS deployment. However, since this positioning method involves three-dimensional (3D) modelling, it often suffers from high computational cost and reconstruction delays (Y. Li et al., 2022). Moreover, issues related to privacy and security may arise, especially when relying on visual data for tracking.

Radio Frequency

RF-based IPS encompass a range of wireless technologies used for estimating the position of targets (receivers) within indoor environments including RFID, UWB, Wi-Fi, and cellular networks. These systems possess distinct characteristics and applications. The technique exploits the behavior of wireless signals as they interact with surrounding objects and obstacles to produce specific signal characteristics that represent the position of a target or receiver. Several common concepts used in RF-based IPS are trilateration, triangulation, fingerprinting, and hybrid approaches. These approaches rely on wireless signal parameters such as RSS, range, and angle measurements.

Radio Frequency Identification

RFID-based technology consists of RFID readers that read the data from RFID tags in the positioning environment. In a typical positioning system setup, RFID tags are attached to the target, while the readers are fixed at a strategic location such as walls and ceilings (Motroni et al., 2021). The readers act as anchors and measure their distance to the target by analysing RSS emitted by the target. RFID is commonly used for indoor positioning due to its availability and specific attributes, making it suitable for various applications. This technology is relatively unaffected by obstacles and walls in the environment, therefore offers fast positioning process. However, it is important to consider the trade-offs between speed, security, and accuracy when evaluating RFID-based IPS for specific applications.

Ultra-Wideband

The term 'wide' in the UWB terminology refers to the ability of the technology to transmit signals simultaneously over multiple bands, specifically in the 3.1 to 10.6 GHz range (Cimdinis et al., 2020; Djosic et al., 2021; J. Wang et al., 2018). UWB technology is an emerging technology used in indoor positioning due to the wide bandwidth it offers. A UWB transmitter emits ultra-short signals, typically in one nanosecond of duration. This special characteristic makes the signals easy to distinguish from the reflected signals caused by the multipath effect. Because of the high penetration ability of UWB, the accuracy of the UWB-based IPS can achieve in the range of tens of centimeters.

A UWB-based IPS revolves around measuring the ToF of UWB signals between a transmitter and a receiver to calculate the distance between them. The common position methods involved in UWB-based IPS are trilateration or multilateration, which rely on multiple UWB transmitters to perform the estimation. UWB is known for its accuracy, especially when considering the 3D geometry of the environment and accounting for reflections caused by walls or objects. One of its applications is in detecting human posture during indoor activities such as indoor sports (Minne et al., 2019; Ridolfi et al., 2018) and mobile user localization (Yoon et al., 2017). Despite the ability to resolve multipath signals, multipath signals propagation still affects the system's performance since UWB signals can be affected by interference from metallic walls in unknown environments. Additionally, adherence to regulatory constraints is crucial, including compliance with power spectral density limits and interference mitigation strategies to ensure coexistence with other wireless systems and avoid regulatory issues.

Wireless Fidelity

Wi-Fi is a more general name of the Wireless Local Area Networks (WLANs) operated based on the IEEE 802.11 standard. This technology facilitates high-speed data transmission and is widely deployed in diverse indoor environments, ranging from homes and universities to malls, hospitals, and airports. Wi-Fi emerges as a preferred choice for indoor positioning due to several advantages including an extended range it provides, ensuring broader coverage within indoor areas compared to technologies like Bluetooth. Moreover, Wi-Fi is a cost-effective option for IPS implementation as it leverages existing infrastructure that offer seamless connectivity to a variety of devices such as smartphones, laptops, desktops, printers, and other. This factor enhances the versatility and scalability in Wi-Fi-based indoor positioning applications.

Most of Wi-Fi-based IPS rely on RSS for estimating location using fingerprinting techniques (Basri & El Khadimi, 2017; Caso et al., 2020; Dai et al., 2020; Shang & Wang, 2022; Song et al., 2019; X. Wang et al., 2020). Therefore, the main challenge of implementing Wi-Fi-based IPS is the variability of Wi-Fi RSS resulting from signal fluctuations, changes in the indoor environment, and device heterogeneity (Basri & El Khadimi, 2017), which impacts the accuracy of fingerprints.

Cellular Networks

Cellular networks have extensive coverage in urban and indoor environments, with numerous BSs providing signals within buildings. Unlike GNSS, cellular signals can penetrate buildings, making it possible for the MS to receive signals while being indoors. With the proliferation of smartphones and the availability of cellular signals in most indoor environments, cellular networks are the best alternative to substitute GNSS signals in indoor environments (Rizk et al., 2021). Similar to UWB, cellular networks also have wide bandwidth that facilitates high temporal resolution. This resolution is pivotal in attaining positional accuracy that approaches the centimeter-level. However, to ensure this accuracy in indoor environments, several factors must be considered to fulfill the demand for high positioning accuracy in indoor applications. The main challenge of implementing cellular-based indoor positioning is that the signals may have low penetration due to walls and other obstacles. Furthermore, range-based cellular positioning requires many BSs, which need to be synchronized at the time of positioning signal transmission for accurate time measurement. These two factors cause traditional range-based estimation methods to be potentially inaccurate due to measurement errors.

There is a need of expanding the coverage in indoor environments by deploying small cells (Rizk, 2019), due to the high demand for indoor mobile data transmission and LBS. Two common types of small cells deployed in confined areas are femtocells and picocells. These small cellular networks resemble Wi-Fi access points but are more versatile, connecting to both outdoor and indoor cellular networks. Femtocells, designed for residential or small office settings, connect to existing broadband internet, providing cellular coverage within a limited area such as a single room or small office space (Naser et al., 2023). On the other hand, picocells, slightly larger than femtocells, are deployed in more extensive indoor environments such as shopping malls, airports, or stadiums, offering coverage over larger areas like a floor or section of a building. Picocells function similarly to macrocells but cover smaller areas, typically 100-200 meters. These BSs are distinguished from their outdoor counterparts, such

as microcells and macrocells, primarily by their operational parameters of power consumption and transmission range. These small cells offer an efficient and targeted solution for enhancing indoor cellular coverage and positioning accuracy. This implementation makes the cellular network a promising wireless technology for IPS implementation.

Indoor Positioning Techniques

Indoor positioning techniques can be classified into range-based and range-free mechanisms. Range-based mechanisms rely on the time or direction measurements of the signal received at the target's location. The major time measurements involved in positioning include TOA and its derivative, TDOA. For angle measurements, AOA is commonly considered in two-dimensional (2D) positioning systems, while both AOA and elevation of arrival (EOA) are necessary for 3D positioning. On the other hand, range-free mechanisms rely on feature-matching strategies, including proximity-based, fingerprinting, pedestrian dead reckoning.

Range-Based Indoor Positioning Techniques

Range-based positioning techniques estimate a target's location based on three-point positioning, utilizing position information contained in electromagnetic wave propagation characteristics, including TOA, TDOA, AOA, and RSS (Deng et al., 2022; Menta et al., 2019; Mosleh et al., 2021). This technique manipulates the measured parameters of the physical uplink and downlink communication layers of the systems. Two classical range-based positioning approaches are trilateration and triangulation.

Trilateration involves determining the location of a point by measuring distance from known reference points. The method requires distance information to the target from at least three reference points to perform position estimation. In classical trilateration methods, the reference points are physical transmitters from which the target receives signals. The distance can be calculated by obtaining the TOA of the signal at the target's location. TOA is the time it takes for a signal to travel from the transmitter to the receiver, which in turn describes circles around the reference devices. If the receiver obtains TOA as evidence, say t_0 , it will estimate range d using the speed of light $c = 3 \times 10^8 \text{m/s}$, where $d = ct_0$. In a 2D positioning system, the estimated position is represented by the intersection of the circles centered at the reference points (Figure 5(a)), while in a 3D positioning system, the intersection of the spheres centered at the reference points represents the estimated point (Figure 5(b)).

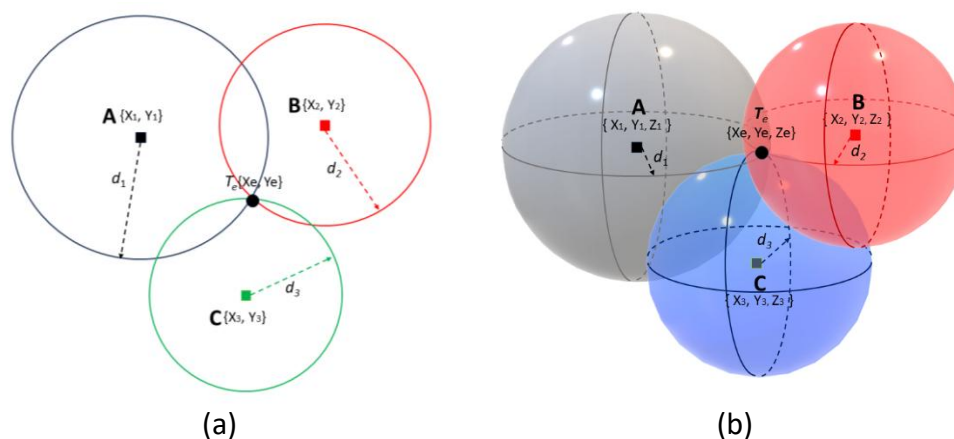

Figure 5: Illustration of trilateration method: (a) 2D system, (b) 3D system

Several challenges emerge when employing TOA measurement techniques in IPS. Firstly, unlike GPS, which relies on predetermined satellite positions established by orbital parameters, indoor positioning lacks a universally accepted reference point. This absence complicates the establishment of a consistent frame of reference for accurate TOA measurements. Secondly, the challenges intensify in the context of indoor spaces due to the significantly shorter distances involved. In such confined environments, the time differences become extremely small, demanding an exceptionally high level of precision (B. Li et al., 2020). The potential for errors in TOA measurements arises from various sources, including ambient noise, limitations in measurement precision, and substantial distortions caused by signal reflections, multipath interference, and scattering phenomena. Consequently, the estimated position is not a precise single point but rather a spatial region. Within this region, the task is to select the point deemed the best estimate, acknowledging the inherent uncertainties introduced by measurement errors and environmental factors in the indoor positioning process.

TDOA-based IPS operate similarly to TOA by utilizing the propagation time from the transmitter to the receiver to estimate distances. However, TDOA does not rely on the exact transmission time, which is sometimes not available (Deng et al., 2022; Manap et al., 2018). These systems calculate the difference in propagation times from each transmitter to estimate distances. This eliminates the necessity to know the time of transmission. Achieving accuracy in measurements still requires synchronization between devices, a prerequisite shared with TOA and other time-based methods. Since TDOA does not rely on the actual distance between the transmitter and the receiver, synchronization is not mandatory between the transmitter and the receiver. This characteristic presents both challenges and opportunities in the context of indoor positioning studies using TDOA. While synchronization complexities persist, the independence from direct distance measurements offers flexibility and potential advantages in certain indoor positioning scenarios.

Triangulation method uses the direction of the signal that arrived at the target's location to determine the location of the target. It involves measuring the angles between two or more known reference points and the object of interest. By using the known distances between the reference points, the angles can be used to calculate the position of the object using geometric principles. Triangulation finds the intersection between measurements from multiple reference points in pointing out the target location, as shown in Figure 6. In the triangulation method, the location of the object in a 2D environment (Figure 6(a)) with at least two reference points (B. Li et al., 2020). AOA provides a measurement of the angle at which a signal is received by the target. The AOA is measured by the receiver based on the direction from which the signal is transmitted with respect to the reference line. In Figure 6(a), θ_1 , θ_2 , and θ_3 represent the AOA of the signal received from points A, B, and C, respectively. The estimated target's location is denoted as $T_e \{X_e, Y_e\}$.

In the 3D triangulation method (Figure 6(b)), there are two angles involved: the azimuth angle and the elevation angle. The azimuth angle refers to the horizontal angle measured anticlockwise from the x -axis as a reference direction. It is commonly called the AOA and provides the horizontal bearing of the target point from a known reference point. As illustrated in Figure 6(b), the AOA of the signal received from A and B are denoted as θ_1 and

θ_2 , respectively, while φ_1 and φ_2 represent the elevation angle, commonly called the EOA, of the signal received from A and B, respectively.

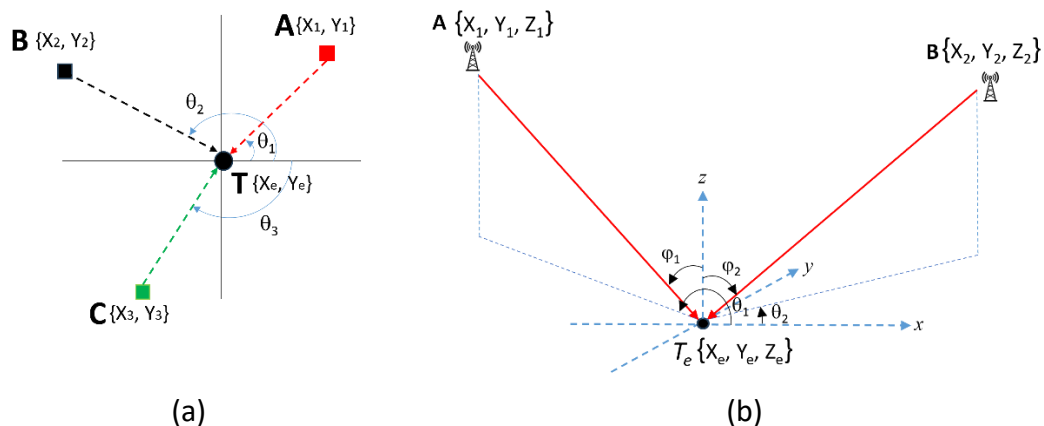

Figure 6: Illustration of triangulation method: (a) 2D system, (b) 3D system

The triangulation method offers the benefit of not necessitating time synchronization among reference points, which simplifies the operational requirements and reduces the complexity of system coordination. However, this method's drawback is the requirement for sophisticated hardware to accurately measure the AOA. This typically involves the use of an array antenna (Deng et al., 2022), which must be capable of processing multi-dimensional received signals to determine the direction from which the signal originates. The complexity of the hardware, along with the associated signal processing algorithms, can pose significant challenges in terms of implementation and cost.

RSS is another valuable parameter used in estimating the distance between a target and a reference point or transmitter. It quantifies the power level of the signal received by the target from the reference point. In this method, the RSS is analyzed to estimate the distance between the target and reference point, typically using techniques such as TOA or TDOA. The RSS is measured at the receiver, and distance is calculated using a signal propagation model or other methods. The RSS method necessitates the use of multilateration to pinpoint the target's location.

In addition to direct manipulations of the measured parameters, many solutions have recommended enhancement techniques by utilizing available system resources such as beam forming (Xiao et al., 2012), multiple input multiple output (MIMO) systems (Awang Md Isa & Markarian, 2011), relay stations (Te Hennepe et al., 2012), and OFDM-based approach (Leria & Lohan, 2012).

In IPS implementation, the accurate estimation of multipath channel delays is a critical step for achieving accurate range-based positioning. The estimation is heavily reliant on the bandwidth of the channel, as a limited bandwidth often results in poor positioning performance due to the challenges in accurately determine the TOA. Several works have proposed mitigation methods to solve this issue. For example, Kazaz et al. (2019) capitalize on the multiband and carrier frequency switching functionalities of wireless transceivers. Their approach involves the acquisition of channel state information (CSI) across multiple frequency bands, thereby exploiting a broad frequency spectrum. The resulting data model exhibits a multiple shift-invariance structure, which the authors leverage to devise a high-

resolution delay estimation algorithm. In (R. Yang et al., 2022), the authors estimated the AOA and ToF from Wi-Fi CSI using a 2D multiple packets-based matrix pencil. This approach significantly reduces computational complexity by employing the discrete Fourier transform (DFT). In addition, it overcomes low signal-to-noise ratio (SNR) issues by accumulating multiple CSI packets. The approach proposed by the authors achieves a positioning accuracy of 42 cm in an indoor hall setting.

In their study, Gonultas et al. (2022), employ a probabilistic method to estimate the position of an MS based on CSI measurements from LAN MIMO-OFDM systems. The CSI measurements are collected from the uplink channel at one or multiple unsynchronized access points (APs). For each AP receiver, the extraction of unique features from the CSI, which are resilient against the system impairments commonly encountered in practical transceivers. These features serve as inputs to a Neural Network (NN) algorithm, which generates a probability map that reflects the likelihood of the MS's presence at specific grid points within the coverage area. The outputs from the NN, corresponding to different APs, are then integrated to produce a final estimated position of the MS. The study presents experimental results obtained from real-world indoor measurements, conducted under both LOS and NLOS propagation conditions. These experiments were performed using an IEEE 802.11ac system with an 80MHz bandwidth, involving an MS equipped with two transmitting antennas and two AP receivers, each with four antennas. The results demonstrate that the proposed approach achieves a median distance error at the centimeter level, representing a significant improvement of an order of magnitude over conventional positioning methods.

Proximity-Based Indoor Positioning Techniques

Proximity-based position estimation techniques determine the target's position by assessing its proximity to a known location which is commonly referred to as a reference point. These techniques rely on detection methods to measure the nearness of the target to the reference point, thereby providing an estimate of the target's location based on this spatial relationship. One common way of implementing proximity sensing is through physical contact between the target and reference points, for instant by touching a tag to a reader equipped with touch sensors, capacitive field sensors, or using technologies such as RFID, Near-Field Communication (NFC), and QR codes (Tariq et al., 2017). Another method of estimating the target's location is by monitoring changes and disturbances in the signal strength within the vicinity of access points. The presence of a target in the vicinity causes changes in the signal strength, which can be detected by the positioning system. For example, surrounding objects, including humans and furniture, affect the propagation of the RF signals (Koh et al., 2021), and give impact on the detection characteristics of the 2.4 GHz wireless signal in the near-field region. Therefore, the target's location can be estimated to be within the range of that reference point.

Proximity-based IPS may offer low-cost and low energy solutions. However, this method suffers from several disadvantages. Firstly, proximity-based methods have limited accuracy since they rely on signal measurements from a nearby beacon or transmitter. In complex indoor environments, the presence of obstacles between transmitter and receiver will deteriorate the signal measurement accuracy. In such cases, the placement of the signal source is crucial, with a LOS configuration being most preferable. Secondly, proximity-based methods provide coarse-grained location information, estimating only the general zone of the

receiver's position. This low precision limits its application for navigation and tracking in indoor environments. Finally, this method requires the installation and maintenance of infrastructure. Not only that, but the implementation also necessitates meticulous planning and arrangement of beacon placement to ensure acceptable positioning accuracy is obtained.

Fingerprinting Indoor Positioning Techniques

Fingerprinting-based indoor positioning is among the most popular techniques found in recent literature (Dai et al., 2020; Djosic et al., 2021; Gao et al., 2021; Shang & Wang, 2022; Tong et al., 2021). Other common names for this technique include pattern matching-based positioning or scene analysis positioning. This technique involves two phases: the site survey stage (also called the offline phase or training phase) and the positioning stage (also called the online phase or testing phase). The traditional technique of fingerprinting positioning is depicted in Figure 7. Offline phase involves the process of fingerprint collection and data storage, while the online phase involves position estimation using a matching algorithm. A fingerprint represents the uniqueness of the signal propagation profile between the transmitter and receiver at a particular position. The characteristic of the fingerprint is heavily influenced by surrounding factors and can include various attributes of wireless signals from Wi-Fi, cellular networks, VLC, Bluetooth, and magnetic fields. A set of fingerprints is measured at reference points in the studied area and stored in the form of vectors in a database. This database serves as the reference for the matching algorithm during the position estimation process.

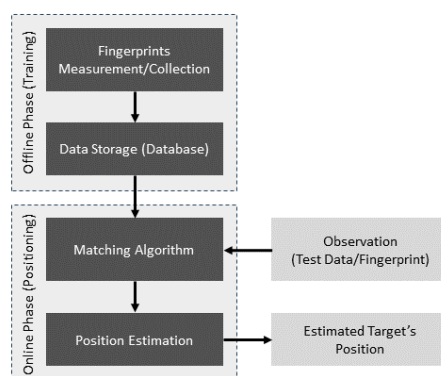

Figure 7: The basic concept of fingerprinting-based indoor positioning

In the matching phase, the attributes collected from the target are compared with the stored fingerprints to estimate the closest location of the target. This technique harnesses the distinctive multipath characteristics of signals to create unique fingerprints at different reference points. Unlike traditional range-based positioning, which is vulnerable to multipath errors, this approach showcases resilience in the face of such challenges. This technique is very feasible as positions are characterized by detected signal patterns, eliminating the complications associated with LOS and NLOS considerations and the need for accurate range or angle measurements. However, it is essential to acknowledge that the training phase of fingerprinting often incurs a notable labor surveying cost. A common method used to conduct a site survey in RSS-based fingerprinting is through RSS measurement at every reference point in the studied area by using a Wi-Fi-compatible mobile device (Caso et al., 2020; Hernández et al., 2021; Shang & Wang, 2022). The precision is determined by the number of pre-created

RSS fingerprints, which is related to the number of RSS reference points and the available signal sources in the environment.

From the review shown in Table 1, it is found that Wi-Fi and cellular networks are the most common sources of signals used in fingerprinting indoor positioning. This is because, in the current communication setup, these two technologies are prominent and the most commonly available systems. Despite their widespread availability almost everywhere, Wi-Fi signals are found to be the most unstable, fluctuating rapidly within short periods, leading to low accuracy in position estimation. In comparison to Wi-Fi, the RSS pattern in cellular networks exhibits greater stability. The RSS in cellular communication systems is typically estimated using the log-distance path loss model. The path loss exponent is the critical factor that distinguishes the RSS of mobile communication signals across different areas. In free space outdoors, the path loss exponent is typically set to 2. However, in urban environments where signal propagation is affected by buildings and other structures, the exponent ranges from 2.7 to 3.5. Indoor settings with a clear line-of-sight, the exponent vary between 1.6 and 1.8. In contrast, obstructed indoor environments yield a higher path loss exponent, ranging from 4 to 6 (El Khaled et al., 2022; Sharma et al., 2023).

A common technique used in fingerprinting methods involves recording and processing the channel parameters (commonly RSS and CSI) transmitted from multiple BSs to provide overlapping received signal patterns in the area of interest. However, the drawback is that this process is labor-intensive and time-consuming. The authors in (Cimdins et al., 2020) extracted the magnitude and phase of the UWB channel impulse response (CIR) to design feature vectors in device-free localization. The authors applied a multipath-assisted concept in a device-free localization system. A propagation model was proposed based on the effect of different user's location in the target area on the received signal.

In IPS implementation, fingerprinting methods specifically those using WiFi and cellular networks, offer several advantages including the low implementation cost due to the widespread availability of these networks. Additionally, with enhancements in data collection, feature selection and matching algorithms, these methods can offer accurate positioning within buildings to facilitate various applications. However, the main challenge faced by these methods is signal instability that can lead to inaccuracies in fingerprints generation. Another challenge to note is the process of fingerprint measurements which are labour intensive and privacy concerns as they often involve collecting and analyzing user data.

Table 1

Technologies and Channel Parameters Used in Indoor Fingerprinting Positioning

Channel Parameter	Technologies						
	Wi-Fi	Cellular Networks	BLE	RF	OFDM signal	Radio Broadcasting	Magnetic
RSS	(Cui et al., 2020; Dai et al., 2020; Hoang et al., 2019; Jin et al., 2020; Le et al., 2021; Liang & Liu, 2020; Mosleh & Daraj, 2021; Poulos & Han, 2021; Yoo, 2020; L. Zhang et al., 2020)	(Alhomayni & Mahoor, 2020; Alkiek et al., 2020; Chai et al., 2020; Rizk & Youssef, 2019; H. Zheng et al., 2020)	(Giuliano et al., 2020; Jiménez et al., 2018; Wysocki et al., 2022)	(Denis et al., 2020; Wye et al., 2021)	(Tsenget al., 2017)	(Duan et al., 2021; M. M. Rahman et al., 2017)	
CSI	(Choi & Choi, 2021; Gao et al., 2021; Tong et al., 2021; X. Wang et al.,	(Song et al., 2019; Ye et al., 2017; J. Zhang et al., 2017)			(Tsenget al., 2017)		

Channel Parameter	Technologies						
	Wi-Fi	Cellular Networks	BLE	RF	OFDM signal	Radio Broadcasting	Magnetic
	2017)						
Magnetic Field							(Fisher et al., 2021)
AOA				(Wielandt et al., 2018; Wielandt & De Strycker, 2017)			
PLE		(J. Zhang et al., 2017)					

Challenges in Indoor Positioning Systems

This section discusses several challenges that might be facing in the IPS implementation. It is important to note that the development of IPS differs from outdoor positioning and navigation due to the complex nature of the surrounding and the signal propagation behaviour. The complexity of multi-dimensional spaces and varying user experiences necessitates innovative solutions that integrate multiple technologies while maintaining user-friendly interfaces. Generally, the challenges are closely related to the signal measurements handling and the design of position estimation algorithms.

Multipath Fading and Line of Sight Issues

Multipath fading is one of the primary challenges in IPS implementation. This error occurs when signals reflect off surfaces, creating multiple paths that can confuse the receiver. This complexity is intensified in scenarios lacking a consistent LOS between the transmitter and receiver, as reflections from walls, furniture, and other obstacles introduce substantial noise and phase shifts into the received signal (Liu et al., 2023; Qi et al., 2024). Multipath interference can lead to destructive effects, including signal fading and inaccuracies in positioning data. Consequently, addressing multipath fading necessitates the development of sophisticated techniques, such as advanced signal processing algorithms and adaptive filtering, to enhance the reliability and precision of indoor positioning.

Device Heterogeneity and RSS Variations

In the realm of smartphone-based IPS, device heterogeneity presents an alarming challenge. This is particularly due to the inherent discrepancies in RSS measurements across various smartphone models. These discrepancies arise from differences in hardware components, antenna designs, and signal processing algorithms, which can significantly affect the accuracy of RSS readings (Sartayeva et al., 2023). Consequently, such variability leads to inconsistencies in positioning accuracy, undermining the reliability of localization solutions. This challenge is

further intensified by the need for universal position estimation algorithms that must accommodate a wide array of devices, each with unique characteristics (Subedi & Pyun, 2020). As a result, the development of robust and adaptable positioning systems becomes increasingly complex, necessitating innovative approaches to mitigate the effects of device heterogeneity on localization performance.

Infrastructure Dependence and Cost Implications

The implementation of IPS often depends on extensive infrastructure to facilitate sufficient signal sources and comprehensive positioning coverage. The needs of installing a large number of transmitters, anchor nodes or beacons not only escalates deployment and maintenance costs but also poses significant barriers for smaller enterprises that may lack the financial resources to invest in such sophisticated systems (Al-Bawri et al., 2022; Ljungzell, 2018). The financial burden associated with infrastructure-heavy indoor positioning system can deter these businesses from adopting advanced positioning technologies, thereby limiting their operational capabilities and competitive edge. Consequently, minimizing infrastructure dependence emerges as a pivotal area for research and development. Innovative approaches, such as collaborative positioning algorithms and single transmitter system deployment (Y. Li et al., 2020; Manap et al., 2023; Schmidt et al., 2024), could potentially alleviate these constraints, fostering broader accessibility and implementation of indoor positioning system across diverse organizational contexts.

Computational Complexity in Real-Time Applications

The implementation of IPS in real-time applications, particularly in navigation and tracking, necessitate systems that operate with minimal latency and high computational efficiency. Current positioning methods, such as fingerprinting and SLAM, often exhibit significant computational complexity (Fang et al., 2021; Hu et al., 2019), which can impede their applicability in scenarios where timely responses are critical. The inherent trade-off between accuracy and computational demands poses a challenge for developers and researchers in this field. Therefore, there is an urgent need for innovative algorithmic approaches that not only enhance the precision of positioning systems but also optimize their computational performance. Future research may focus on the development of hybrid models that effectively reconcile these competing requirements, thereby facilitating the deployment of robust real-time applications.

Privacy and Security Concerns

The privacy and security concerns are another challenge to focus since the implementation of IPS necessitates the access of position related information that might involves the collection and processing of sensitive location data. The inherent risks associated with unauthorized access to, and manipulation of this data necessitate the development and implementation of robust secure positioning mechanisms (Holcer et al., 2020; H. Yang et al., 2022). Therefore, the algorithms must incorporate advanced encryption techniques, access controls, and user authentication protocols to safeguard sensitive information. Furthermore, ongoing research in this domain is essential for enhancing user trust, as it directly impacts the willingness of individuals to engage with IPS technologies. Compliance with stringent data protection regulations, such as the General Data Protection Regulation (GDPR) (Tamburri, 2020), is also critical to ensure ethical handling of location data and to mitigate potential legal repercussions.

Conclusion

In conclusion, the development of accurate IPS is critical for fulfilling the demand of advanced LBS in the current technology-driven society which highly dependence on digital communication and IoT. This review highlights various IPS technologies and techniques proposed in recent works. The review findings indicate the importance of tailoring solutions to meet specific user and environmental needs by enhancing the signal processing techniques and position estimation algorithms. Future research in IPS development necessitate consideration on the challenges imposed by the environmental and regulatory factors, such as signal instability, infrastructure dependence, and privacy concerns. Developing hybrid models that reconcile the trade-offs between accuracy and computational efficiency, as well as implementing robust security measures to protect sensitive location data are among the potential focus for future research. By addressing these challenges, the potential for IPS to transform industries and improve user experiences can be fully realized.

Acknowledgement

The authors would like to thank Universiti Teknikal Malaysia Melaka (UTeM) and Fakulti Teknologi dan Kejuruteraan Elektronik dan Komputer (FTKEK) for the support.

References

- 3GPP. (2017). *Digital cellular telecommunications system (Phase 2+) (GSM); Universal Mobile Telecommunications System (UMTS); LTE; Functional stage 2 description of Location Services (LCS)-TS 123 271 - V14.2.0*.
- Abdullah, R.S., Hakimi, H., & Kamalrudin, M. (2024). Software Security Readiness Index for Remote Working Employee in Public Organization: Preliminary Study. *International Journal of Academic Research in Business and Social Sciences*
- Abed, F. A., Hamza, Z. A., & Mosleh, M. F. (2022). Indoor Positioning System Based on Wi-Fi and Bluetooth Low Energy. *International Engineering Conference: Towards Engineering Innovations and Sustainability*, 136–141.
- Abid, M., Compagnon, P., & Lefebvre, G. (2021). Improved CNN-based Magnetic Indoor Positioning System using Attention Mechanism. *International Conference on Indoor Positioning and Indoor Navigation (IPIN)*, 1–8.
- Alhomayani, F., & Mahoor, M. (2020). Deep Learning-based Symbolic Indoor Positioning using the Serving eNodeB. *IEEE International Conference on Machine Learning and Applications (ICMLA)*, 489–494.
- Alkhwaja, F., Jaradat, M., & Romdhane, L. (2019). Techniques of Indoor Positioning Systems (IPS): A Survey. *Advances in Science and Engineering Technology International Conferences (ASET), IEEE (2019)*, 1–8.
- Alkiek, K., Othman, A., Rizk, H., & Youssef, M. (2020). Deep Learning-based Floor Prediction using Cell Network Information. *Proceedings of the ACM International Symposium on Advances in Geographic Information Systems*, 663–664.
- Andrade, R. M., Paulo, R. R., Francisco, S. M., Teixeira, E., & Velez, F. J. (2021). Characterization of Indoor Small Cells Propagation. *International Symposium on Wireless Personal Multimedia Communications (WPMC), 2021-December*, 1–6.
- Antsfeld, L., & Chidlovskii, B. (2021). Magnetic Field Sensing for Pedestrian and Robot Indoor Positioning. *International Conference on Indoor Positioning and Indoor Navigation (IPIN)*, 1–8.

- Asaad, S. M., Potrus, M. Y., Ghafoor, K. Z., Maghdid, H. S., & Mulahuwaish, A. (2022). Improving Positioning Accuracy Using Optimization Approaches: A Survey, Research Challenges and Future Perspectives. *Wireless Personal Communications*, 122(4), 3393–3409.
- Awang Md Isa, A., & Markarian, G. (2011). MIMO Positioning for IMT-Advanced Systems based on Geometry Approach in NLOS Environments. *Journal of Telecommunication, Electronic and Computer Engineering*, 3(1), 55–68.
- Basri, C., & El Khadimi, A. (2017). Survey on Indoor Localization System and Recent Advances of WIFI Fingerprinting Technique. *International Conference on Multimedia Computing and Systems*, 0, 253–259.
- Caso, G., De Nardis, L., Lemic, F., Handziski, V., Wolisz, A., & Benedetto, M. G. Di. (2020). ViFi: Virtual Fingerprinting WiFi-Based Indoor Positioning via Multi-Wall Multi-Floor Propagation Model. *IEEE Transactions on Mobile Computing*, 19(6), 1478–1491.
- Chai, M., Li, C., & Huang, H. (2020). A New Indoor Positioning Algorithm of Cellular and Wi-Fi Networks. *Journal of Navigation*, 73(3), 509–529.
- Choi, J., & Choi, Y. S. (2021). Calibration-Free Positioning Technique using Wi-Fi Ranging and Built-In Sensors of Mobile Devices. *IEEE Internet of Things Journal*, 8(1), 541–554.
- Cimdins, M., Schmidt, S. O., & Hellbrück, H. (2020). MAMPI-UWB—Multipath-Assisted Device-Free Localization with Magnitude and Phase Information with UWB Transceivers. *Sensors (Switzerland)*, 20(24), 1–23.
- Cui, X., Yang, J., Li, J., & Wu, C. (2020). Improved Genetic Algorithm to Optimize the Wi-Fi Indoor Positioning based on Artificial Neural Network. *IEEE Access*, 8(2020), 74914–74921.
- Dai, S., He, L., & Zhang, X. (2020). Autonomous WiFi Fingerprinting for Indoor Localization. *International Conference on Cyber-Physical Systems (ICCPS)*, 141–150.
- Delabie, D., Wilding, T., Van Der Perre, L., & De Strycker, L. (2023). Anchor Layout Optimization for Ultrasonic Indoor Positioning using Swarm Intelligence. *International Conference on Indoor Positioning and Indoor Navigation (IPIN)*, 1–6.
- Deng, Z., Wu, J., Wang, S., & Zhang, M. (2022). Indoor Localization with a Single Access Point based on TDoA and AoA. *Wireless Communications and Mobile Computing*, 2022(1), 1–10.
- Denis, S., Kaya, A., Berkvens, R., & Weyn, M. (2020). Device-Free Localization and Identification using Sub-GHz Passive Radio Mapping. *Applied Sciences (Switzerland)*, 10(18), 1–22.
- Djosic, S., Stojanovic, I., Jovanovic, M., Nikolic, T., & Djordjevic, G. L. (2021). Fingerprinting-assisted UWB-based Localization Technique for Complex Indoor Environments. *Expert Systems with Applications*, 167(2021), 1–14.
- Duan, C., Tian, L., Bai, P., & Peng, B. (2021). A Frequency Modulation Fingerprint-Based Positioning Algorithm for Indoor Mobile Localization of Photoelectric Modules. *Frontiers in Physics*, 8(2021), 1–8.
- El Khaled, Z., Ajib, W., & McHeick, H. (2022). Log Distance Path Loss Model: Application and Improvement for Sub 5 GHz Rural Fixed Wireless Networks. *IEEE Access*, 10, 52020–52029.
- Fang, W., Xie, C., & Ran, B. (2021). An Accurate and Real-Time Commercial Indoor Localization System in LTE Networks. *IEEE Access*, 9, 21167–21179.

- Fisher, E., Ivry, A., Alimi, R., & Weiss, E. (2021). Smartphone Based Indoor Localization using Permanent Magnets and Artificial Intelligence for Pattern Recognition. *AIP Advances*, *11*(1), 1–6.
- Fuschini, F., Vitucci, E. M., Barbiroli, M., Falciasecca, G., & Degli-Esposti, V. (2015). Ray Tracing Propagation Modeling for Future Small-Cell and Indoor Applications: A Review of Current Techniques. *Radio Science*, *50*(6), 469–485.
- Gao, Z., Gao, Y., Wang, S., Li, D., & Xu, Y. (2021). CRISLoc: Reconstructable CSI Fingerprinting for Indoor Smartphone Localization. *IEEE Internet of Things Journal*, *8*(5), 3422–3437.
- Gentner, C., Pöhlmann, R., Ulmschneider, M., Jost, T., & Zhang, S. (2017). Positioning using Terrestrial Multipath Signals and Inertial Sensors. *Mobile Information Systems*, *2017*(1), 9170746.
- Giuliano, R., Cardarilli, G. C., Cesarini, C., Di Nunzio, L., Fallucchi, F., Fazzolari, R., Mazzenga, F., Re, M., & Vizzarri, A. (2020). Indoor Localization System Based on Bluetooth Low Energy for Museum Applications. *Electronics*, *9*(6), 1055.
- Gonultas, E., Lei, E., Langerman, J., Huang, H., & Studer, C. (2022). CSI-Based Multi-Antenna and Multi-Point Indoor Positioning Using Probability Fusion. *IEEE Transactions on Wireless Communications*, *21*(4), 2162–2176.
- Gualda, D., Pérez-rubio, M. C., Ureña, J., Pérez-bachiller, S., Villadangos, J. M., Hernández, Á., García, J. J., & Jiménez, A. (2021). Locate-Us: Indoor Positioning for Mobile Devices using Encoded Ultrasonic Signals, Inertial Sensors and Graph-Matching. *Sensors*, *21*(6), 1–25.
- Guo, X., Ansari, N., Hu, F., Shao, Y., Elikplim, N. R., & Li, L. (2020). A Survey on Fusion-based Indoor Positioning. *IEEE Communications Surveys and Tutorials*, *22*(1), 566–594.
- Hakimi, H., & Nabilah, A. (2024). Book Recommendation System (BRS) Using Collaboration Filtering Machine Learning. In *Opportunities and Risks in AI for Business Development: Volume 1* (pp. 993-1002). Cham: Springer Nature Switzerland.
- Hernández, N., Parra, I., Corrales, H., Izquierdo, R., Ballardini, A. L., Salinas, C., & García, I. (2021). WiFiNet: WiFi-based Indoor Localisation using CNNs. *Expert Systems with Applications*, *177*(2021), 114906.
- Hoang, M. T., Yuen, B., Dong, X., Lu, T., Westendorp, R., & Reddy, K. (2019). Recurrent Neural Networks for Accurate RSSI Indoor Localization. *IEEE Internet of Things Journal*, *6*(6), 10639–10651.
- Holcer, S., Torres-Sospedra, J., Gould, M., & Remolar, I. (2020). Privacy in Indoor Positioning Systems: A Systematic Review. *International Conference on Localization and GNSS, ICL-GNSS 2020*.
- Hu, G., Feldhaus, P., Feng, Y., Wang, S., Zheng, J., Duan, H., & Gu, J. (2019). Accuracy Improvement of Indoor Real-Time Location Tracking Algorithm for Smart Supermarket Based on Ultra-Wideband. *International Journal of Pattern Recognition and Artificial Intelligence*, *33*(12).
- Huang, C., Hendeby, G., Fourati, H., Prieur, C., & Skog, I. (2024). MAINS: A Magnetic-Field-Aided Inertial Navigation System for Indoor Positioning. *IEEE Sensors Journal*, *24*(9), 15156–15166.
- Huang, J., Junginger, S., Liu, H., & Thurow, K. (2023). Indoor Positioning Systems of Mobile Robots: A Review. *Robotics*, *12*(2), 47.
- Ismail, N. F., Akmal, S., Mohd, Massila Kamalrudin, Amirul Affiq, Hakimi, H., & Azmi, S. S. (2024). Agile Decision-Making as an Alternative for Decision Making's Complexities in Information Management to Flood Rescue and Recovery: A Systematic Literature

- Review. *Journal of Advanced Research in Applied Sciences and Engineering Technology*, 89–105. <https://doi.org/10.37934/araset.58.1.89105>
- Jespersen, M. H., Serup, D. E., Nielsen, M. H., Hannesbo, M. H., Williams, R. J., Nielsen, K. S., Mikkelsen, J. H., & Shen, M. (2018). An Indoor Multipath-Assisted Single-Anchor UWB Localization Method. *IEEE MTT-S International Wireless Symposium (IWS)*, 1–3.
- Jiménez, A. R., Seco, F., Peltola, P., & Espinilla, M. (2018). Location of Persons using Binary Sensors and BLE Beacons for Ambient Assistive Living. *International Conference on Indoor Positioning and Indoor Navigation (IPIN)*, 24–27.
- Jin, F., Liu, K., Zhang, H., Ng, J. K. Y., Guo, S., Lee, V. C. S., & Son, S. H. (2020). Toward Scalable and Robust Indoor Tracking: Design, Implementation, and Evaluation. *IEEE Internet of Things Journal*, 7(2), 1192–1204.
- Kazaz, T., Janssen, G. J. M., & Van Der Veen, A. J. (2019). Time Delay Estimation from Multiband Radio Channel Samples in Nonuniform Noise. *Asilomar Conference on Signals, Systems and Computers, 2019-November*, 1237–1241.
- Koh, D. Y., Han, T. S., & Zubah, J. (2021). Electromagnetic Wave Sensor for Proximity Target Detection Under Radio and Radar Coexistence at 2.4-GHz ISM Band. *IEEE Sensors, 2021*, 1–4.
- Kulmer, J., Hinteregger, S., Grosswindhager, B., Rath, M., Bakr, M. S., Leitinger, E., & Witrisal, K. (2017). Using DecaWave UWB Transceivers for High-Accuracy Multipath-Assisted Indoor Positioning. *International Conference on Communications Workshops*, 1239–1245.
- Kulmer, J., Leitinger, E., Meissner, P., Hinteregger, S., & Witrisal, K. (2016). Cooperative localization and tracking using multipath channel. *International Conference on Localization and GNSS (ICL-GNSS)*, 1–6.
- Kusche, R., Schmidt, S. O., & Hellbruck, H. (2021). Indoor Positioning via Artificial Magnetic Fields. *IEEE Transactions on Instrumentation and Measurement*, 70(2021), 8502509.
- Kwak, M., Hamm, C., Park, S., & Kwon, T. T. (2019). Magnetic Field based Indoor Localization System: A Crowdsourcing Approach. *International Conference on Indoor Positioning and Indoor Navigation (IPIN)*, 1–8.
- Le, Y., Jin, S., Zhang, H., Shi, W., & Yao, H. (2021). Fingerprinting Indoor Positioning Method Based on Kernel Ridge Regression with Feature Reduction. *Wireless Communications and Mobile Computing*, 2021(1), 6631585.
- Leitinger, E., Grebien, S., Witrisal, K., Li, X., & Tufvesson, F. (2018). On the Use of MPC Amplitude Information in Radio Signal Based SLAM. *IEEE Statistical Signal Processing Workshop (SSP)*, 633–637.
- Leria, V. J., & Lohan, E.-Si. (2012). Timing-based location estimation for OFDM signals with application in LTE, WLAN and WIMAX. *International Conference on Localization and GNSS*, 1–5.
- Li, B., Zhao, K., & Shen, X. (2020). Dilution of Precision in Positioning Systems using Both Angle of Arrival and Time of Arrival Measurements. *IEEE Access*, 8, 192506–192516.
- Li, K., Gong, Q., Ren, Y., Li, Y., Han, Y., Pang, C., & Kong, H. (2022). Magnetic Field Positioning Technology of Indoor Sports Bodies. *IEEE Sensors Journal*, 22(1), 219–228.
- Li, X. (2019). Cellular Base Station Assisted Indoor Positioning. *IEEE Transactions on Aerospace and Electronic Systems*, 55(2), 592–606.
- Li, Y., Kambhamettu, R. H., Hu, Y., & Zhang, R. (2022). ImPos: An Image-Based Indoor Positioning System. *Annual Consumer Communications & Networking Conference (CCNC)*, 144–150.

- Liang, Q., & Liu, M. (2020). An Automatic Site Survey Approach for Indoor Localization Using a Smartphone. *IEEE Transactions on Automation Science and Engineering*, 17(1), 191–206.
- Liu, Z., Chen, L., Zhou, X., Shen, N., & Chen, R. (2023). Multipath tracking with LTE signals for accurate TOA estimation in the application of indoor positioning. *Geo-Spatial Information Science*, 26(1), 31–43.
- Ljungzell, E. (2018). *Multipath-assisted Single-anchor Outdoor Positioning in Urban Environments*. Linköping University.
- Maheepala, M., Kouzani, A. Z., & Joordens, M. A. (2020). Light-Based Indoor Positioning Systems: A Review. *IEEE Sensors Journal*, 20(8), 3971–3995.
- Manap, Z., Awang Md Isa, A., Zainuddin, S., Mohd Sultan, J., & Markarian, G. (2023). Analysis of Single Transmitter 3D Indoor Positioning based on Virtual Transmitter Concept. *Przeglad Elektrotechniczny*, 2023(9), 179.
- Manap, Z., Isa, A. A. M., Mohd Zain, A. S., Darsono, A. M., & Othman, M. H. (2018). Implementation of Particle Filtering in TDOA Positioning. *Journal of Telecommunication, Electronic and Computer Engineering*, 10(2–8), 103–107.
- Menta, E. Y., Malm, N., Jantti, R., Ruttik, K., Costa, M., & Leppanen, K. (2019). On the Performance of AoA-Based Localization in 5G Ultra-Dense Networks. *IEEE Access*, 7, 33870–33880.
- Minne, K., Macoir, N., Rossey, J., Van Den Brande, Q., Lemey, S., Hoebeke, J., & De Poorter, E. (2019). Experimental Evaluation of UWB Indoor Positioning for Indoor Track Cycling. *Sensors*, 19(9), 2041.
- Miramirkhani, F., & Uysal, M. (2015). Channel Modeling and Characterization for Visible Light Communications. *IEEE Photonics Journal*, 7(6), 1–16.
- Morar, A., Moldoveanu, A., Mocanu, I., Moldoveanu, F., Radoi, I. E., Asavei, V., Gradinaru, A., & Butean, A. (2020). A Comprehensive Survey of Indoor Localization Methods based on Computer Vision. *Sensors (Switzerland)*, 20(9), 2641.
- Mosleh, M. F., & Daraj, A. K. (2021). Evaluation of Dynamic Localization System Based on UWB and Wi-Fi for Indoor Environments. *Journal of Physics: Conference Series*, 1773(1), 012003.
- Mosleh, M. F., Zaiter, M. J., & Hashim, A. H. (2021). Position Estimation Using Trilateration based on ToA/RSS and AoA Measurement. *Journal of Physics: Conference Series*, 1773(1), 012002.
- Motroni, A., Buffi, A., & Nepa, P. (2021). A Survey on Indoor Vehicle Localization through RFID Technology. *IEEE Access*, 9, 17921–17942.
- Naser, R. S., Lam, M. C., Qamar, F., & Zaidan, B. B. (2023). Smartphone-Based Indoor Localization Systems: A Systematic Literature Review. In *Electronics (Switzerland)* (Vol. 12, Issue 8). MDPI.
- Poulose, A., & Han, D. S. (2021). Hybrid Deep Learning Model Based Indoor Positioning using Wi-Fi RSSI Heat Maps for Autonomous Applications. *Electronics (Switzerland)*, 10(1), 1–15.
- Qi, L., Liu, Y., Yu, Y., Chen, L., & Chen, R. (2024). Current Status and Future Trends of Meter-Level Indoor Positioning Technology: A Review. *Remote Sensing*, 16(2).
- Rahman, A. B. M. M., Li, T., & Wang, Y. (2020). Recent Advances in Indoor Localization via Visible Lights: A Survey. *Sensors (Switzerland)*, 20(5), 1382.

- Rahman, M. M., Moghtadaiee, V., & Dempster, A. G. (2017). Design of Fingerprinting Technique for Indoor Localization using AM Radio Signals. *International Conference on Indoor Positioning and Indoor Navigation (IPIN), 2017-January*, 1–7.
- Rath, M., Kulmer, J., Bakr, M. S., Groswindhager, B., & Witrissal, K. (2017). Multipath-assisted indoor positioning enabled by directional UWB sector antennas. *IEEE Workshop on Signal Processing Advances in Wireless Communications (SPAWC), 2017-July*, 1–5.
- Ridolfi, M., Vandermeeren, S., Defraye, J., Steendam, H., Gerlo, J., Clercq, D. De, Hoebeke, J., & Poorter, E. De. (2018). Experimental Evaluation of UWB Indoor Positioning for Sport Postures. *Sensors (Switzerland)*, 18(1), 168.
- Rizk, H. (2019). Device-invariant Cellular-based Indoor Localization System using Deep Learning. *Proceedings of the ACM MobiSys-RisingStarsForum*, 19–23.
- Rizk, H., Abbas, M., & Youssef, M. (2021). Device-independent cellular-based indoor location tracking using deep learning. *Pervasive and Mobile Computing*, 75.
- Rizk, H., & Youssef, M. (2019). MonoDCell: A Ubiquitous and Low-Overhead Deep Learning-based Indoor Localization with Limited Cellular Information. *Proceedings of the ACM International Symposium on Advances in Geographic Information Systems*, 109–118.
- Sarbazi, E., Uysal, M., Abdallah, M., & Qaraqe, K. (2014). Indoor Channel Modelling and Characterization for Visible Light Communications. *International Conference on Transparent Optical Networks*, 1–4.
- Sartayeva, Y., Chan, H. C. B., Ho, Y. H., & Chong, P. H. J. (2023). A survey of indoor positioning systems based on a six-layer model. *Computer Networks*, 237.
- Sesyuk, A., Ioannou, S., & Raspopoulos, M. (2022). A Survey of 3D Indoor Localization Systems and Technologies. *Sensors*, 22(23), 9380.
- Shang, S., & Wang, L. (2022). Overview of WiFi Fingerprinting-based Indoor Positioning. *IET Communications*, 16(7), 725–733.
- Sharma, S., Jha, R., & Kumar, A. (2023). Path-Loss Model Evaluation for 6G in Indoor Propagation. *World Conference on Communication and Computing (WCONF)*, 1–6.
- Song, X., Fan, X., Xiang, C., Ye, Q., Liu, L., Wang, Z., He, X., Yang, N., & Fang, G. (2019). A Novel Convolutional Neural Network Based Indoor Localization Framework with WiFi Fingerprinting. *IEEE Access*, 7, 110698–110709.
- Subedi, S., & Pyun, J. Y. (2020). A Survey of Smartphone-based Indoor Positioning System using RF-based Wireless Technologies. In *Sensors (Switzerland)* (Vol. 20, Issue 24, pp. 1–32). MDPI AG.
- Tamburri, D. A. (2020). Design principles for the General Data Protection Regulation (GDPR): A formal concept analysis and its evaluation. *Information Systems*, 91, 101469.
- Tariq, Z. Bin, Cheema, D. M., Kamran, M. Z., & Naqvi, I. H. (2017). Non-GPS positioning systems: A survey. *ACM Computing Surveys*, 50(4), 57.
- Te Hennepe, D. H., Van Den Berg, J. L., & Karagiannis, G. (2012). Impact of Relay Station Positioning on LTE Uplink Performance at Flow Level. *IEEE Global Telecommunications Conference*, 1586–1592.
- Tong, X., Wan, Y., Li, Q., Tian, X., & Wang, X. (2021). CSI Fingerprinting Localization with Low Human Efforts. *IEEE/ACM Transactions on Networking*, 29(1), 372–385.
- Tseng, P. H., Chan, Y. C., Lin, Y. J., Lin, D. B., Wu, N., & Wang, T. M. (2017). Ray-Tracing-Assisted Fingerprinting Based on Channel Impulse Response Measurement for Indoor Positioning. *IEEE Transactions on Instrumentation and Measurement*, 66(5), 1032–1045.

- Ulmschneider, M., & Gentner, C. (2016). Multipath Assisted Positioning for Pedestrians using LTE Signals. *Proceedings of the IEEE/ION Position, Location and Navigation Symposium*, 386–392.
- Ulmschneider, M., Gentner, C., Jost, T., & Dammann, A. (2017a). Association of Transmitters in Multipath-Assisted Positioning. *IEEE Global Communications Conference*, 1–7.
- Ulmschneider, M., Gentner, C., Jost, T., & Dammann, A. (2017b). Multiple Hypothesis Data Association for Multipath-Assisted Positioning. *Workshop on Positioning, Navigation and Communications*, 1–6.
- Ulmschneider, M., Gentner, C., Jost, T., & Dammann, A. (2018). Rao-Blackwellized Gaussian Sum Particle Filtering for Multipath Assisted Positioning. *Journal of Electrical and Computer Engineering*, 2018(1), 4761601.
- Ulmschneider, M., Raulefs, R., Gentner, C., & Walter, M. (2016). Multipath Assisted Positioning in Vehicular Applications. *Workshop on Positioning, Navigation and Communication*, 1–6.
- Veenoth, A., Shankarvelu, L., Hakimi, H., Marlia, Z., & Octaviani, D. (2023). Food Donation Application to Improve the Distribution and Verification Process Within Selangor: Feedback. *Journal of Applied Technology and Innovation (e-ISSN: 2600-7304)*, 7(3), 7.
- Wang, J., Tang, Y., Munoz-Ferreras, J. M., Gomez-Garcia, R., & Li, C. (2018). An Improved Indoor Localization Solution using a Hybrid UWB-Doppler System with Kalman filter. *IEEE Radio and Wireless Symposium (RWS), 2018-January*, 181–183.
- Wang, X., Chen, Z., Zhang, S., & Zhu, J. (2020). Super-Resolution Based Fingerprint Augment for Indoor WiFi Localization. *IEEE Global Communications Conference (GLOBECOM), 2020-January*, 1–6.
- Wang, X., Gao, L., Mao, S., & Pandey, S. (2017). CSI-Based Fingerprinting for Indoor Localization: A Deep Learning Approach. *IEEE Transactions on Vehicular Technology*, 66(1), 763–776.
- Wielandt, S., & De Strycker, L. (2017). Indoor Multipath Assisted Angle of Arrival Localization. *Sensors (Switzerland)*, 17(11), 29.
- Wielandt, S., De Strycker, L., Strycker, L., & De Strycker, L. (2017). Indoor multipath assisted angle of arrival localization. *Sensors (Switzerland)*, 17(11), 29.
- Wielandt, S., Thoen, B., & De Strycker, L. (2018). Experimental Evaluation of a Single Anchor Multipath Assisted Indoor Angle of Arrival Localization System in the 2.4 GHz and 5 GHz Band. *International Conference on Indoor Positioning and Indoor Navigation (IPIN)*, 1–7.
- Witrisal, K., Hinteregger, S., Kulmer, J., Leitinger, E., & Meissner, P. (2016). High-accuracy positioning for indoor applications: RFID, UWB, 5G, and beyond. *IEEE International Conference on RFID*, 1–7.
- Witrisal, K., Meissner, P., Leitinger, E., Shen, Y., Gustafson, C., Tufvesson, F., Haneda, K., Dardari, D., Molisch, A. F., Conti, A., & Win, M. Z. (2016). High-Accuracy Localization for Assisted Living: 5G Systems will Turn Multipath Channels from Foe to Friend. *IEEE Signal Processing Magazine*, 33(2), 59–70.
- Wye, K. F. P., Zakaria, S. M. M. S., Kamarudin, L. M., Zakaria, A., Ahmad, N. B., & Kamarudin, K. (2021). RSS-based Fingerprinting Localization with Artificial Neural Network. *Journal of Physics: Conference Series*, 1755(1), 012033.
- Wysocki, M., Nicpoń, R., Trzaska, M., & Czapiewska, A. (2022). Research of Accuracy of RSSI Fingerprint-Based Indoor Positioning BLE System. *Przegląd Elektrotechniczny*, 98(9), 86–89.

- Xiao, D., Yuxiaoyu, & Yang, D. (2012). A Novel Downlink ICIC Method Based on User Position in LTE-Advanced Systems. *IEEE Vehicular Technology Conference (VTC Fall)*, 1–5.
- Xie, C., Guan, W., Wu, Y., Fang, L., & Cai, Y. (2018). The LED-ID Detection and Recognition Method Based on Visible Light Positioning Using Proximity Method. *IEEE Photonics Journal*, 10(2), 7902116.
- Yan, S., Su, Y., Sun, A., Ji, Y., Xiao, J., & Chen, X. (2022). Low-cost and Lightweight Indoor Positioning Based on Computer Vision. *ACM International Conference Proceeding Series*, 169–175.
- Yang, H., Vijayakumar, P., Shen, J., & Gupta, B. B. (2022). A location-based privacy-preserving oblivious sharing scheme for indoor navigation. *Future Generation Computer Systems*, 137, 42–52.
- Yang, R., Yang, X., Wang, J., Zhou, M., Tian, Z., & Li, L. (2022). Decimeter Level Indoor Localization Using WiFi Channel State Information. *IEEE Sensors Journal*, 22(6), 4940–4950.
- Yang, Y., Liu, J., Wang, W., Cao, Y., & Li, H. (2021). Incorporating SLAM and Mobile Sensing for Indoor CO₂ Monitoring and Source Position Estimation. *Journal of Cleaner Production*, 291(2021), 1–13.
- Ye, X., Yin, X., Cai, X., Perez Yuste, A., & Xu, H. (2017). Neural-Network-Assisted UE Localization Using Radio-Channel Fingerprints in LTE Networks. *IEEE Access*, 5, 12071–12087.
- Yoo, J. (2020). Change Detection of RSSI Fingerprint Pattern for Indoor Positioning System. *IEEE Sensors Journal*, 20(5), 2608–2615.
- Yoon, P. K., Zihajehzadeh, S., Kang, B. S., & Park, E. J. (2017). Robust Biomechanical Model-Based 3-D Indoor Localization and Tracking Method Using UWB and IMU. *IEEE Sensors Journal*, 17(4), 1084–1096.
- You, Y., & Wu, C. (2020). Indoor Positioning System with Cellular Network Assistance Based on Received Signal Strength Indication of Beacon. *IEEE Access*, 8, 6691–6703.
- Yu, K., Wen, K., Li, Y., Zhang, S., & Zhang, K. (2019). A Novel NLOS Mitigation Algorithm for UWB Localization in Harsh Indoor Environments. *IEEE Transactions on Vehicular Technology*, 68(1), 686–699.
- Zafari, F., Gkelias, A., & Leung, K. K. (2019). A Survey of Indoor Localization Systems and Technologies. *IEEE Communications Surveys and Tutorials*, 21(3), 2568–2599.
- Zhang, J., Han, G., Sun, N., & Shu, L. (2017). Path-Loss-Based Fingerprint Localization Approach for Location-based Services in Indoor Environments. *IEEE Access*, 5, 13756–13769.
- Zhang, L., Zhao, C., Wang, Y., & Dai, L. (2020). Fingerprint-based Indoor Localization using Weighted K-Nearest Neighbor and Weighted Signal Intensity. *ACM International Conference Proceeding Series*, 185–191.
- Zheng, H., Zhong, X., & Liu, P. (2020). RSS-based Indoor Passive Localization Using Clustering and Filtering in a LTE Network. *IEEE Vehicular Technology Conference, 2020-May*, 1–6.
- Zheng, Y., Li, Q., Wang, C., Li, X., & Yang, B. (2021). A Magnetic-Based Indoor Positioning Method on Fingerprint and Confidence Evaluation. *IEEE Sensors Journal*, 21(5), 5932–5943.
- Zhou, B., Xie, D., Chen, S., Li, C., & Mo, H. (2022). LI-SLAM: Fusing LiDAR and Infrared Camera for Simultaneous Localization and Mapping. *International Conference on Indoor Positioning and Indoor Navigation (IPIN-WiP)*, 1–11.
- Zou, H., Jin, M., Jiang, H., Xie, L., & Spanos, C. J. (2017). WinIPS: WiFi-based Non-Intrusive Indoor Positioning System with Online Radio Map Construction and Adaptation. *IEEE Transactions on Wireless Communications*, 16(12), 8118–8130.